



***Sistemi***

**Sistemi e Componenti per  
l'Automazione e Fluidi  
Civili e Industriali**

# **LISTINO 2021**

(VALIDO DAL 01-03-2021)

# Indice

## ARREDAMENTO SALA OPERATORIA

Lavabo per chirurgo .....	pag. 3
Tunnel passasporco .....	pag. 8
Finestra passaferri .....	pag. 9
Pareti tecniche attrezzate .....	pag. 10
Armadi .....	pag. 12
Arredi vari .....	pag. 13

## ARREDAMENTO SALA LAVAGGIO

Portapappagalli e portapadelle .....	pag. 17
Vuotatoio .....	pag. 18

## STERILIZZAZIONE

Banco lavaggio ad ultrasuoni .....	pag. 20
Carrelli portacontainers .....	pag. 21
Tavoli confezionamento .....	pag. 22

## ARREDI NEUTRI

Lavello sala gessi .....	pag. 24
Carrelli deposito salme .....	pag. 25
Tavoli su gambe .....	pag. 27
Banchi armadiati .....	pag. 30
Cassettiere .....	pag. 33
Lavatoio armadiato .....	pag. 36
Lavatoio su gambe .....	pag. 39
Lavamani .....	pag. 41
Armadi e pensili .....	pag. 43
Carrelli .....	pag. 47
Carrelli medicali .....	pag. 49
Carrelli biancheria .....	pag. 51
Accessori .....	pag. 52
Scaffalature .....	pag. 55
Mensole .....	pag. 58

# Arredamento sala operatoria

## LAVABO PER CHIRURGO

### Surgical sink

LAVABO PER CHIRURGO interamente in acciaio inox AISI 304 finitura scotch-brite

- Vasca sagomata antispruzzo e trattata con antirombo adesivo
- Spigoli arrotondati con bordi a doppia piega antitaglio, garanzia di una veloce ed agevole pulizia anche in condizioni di sporco accumulato
- Gruppi erogatori manuali a leva clinica, con comando a pedale o elettronici con comando a fotocellula (alimentazione dalla rete o tramite batteria al litio di lunga durata)
- Pannello anteriore asportabile
- Disponibile nella versione da uno, due, tre e quattro posti
- ACCESSORI: dispensatori di spazzolini monouso, distributore di sapone liquido interamente in acciaio inox con comando a gomito o elettronico, dispositivo di controllo termostatico della temperatura per un controllo ottimale della temperatura dell'acqua
- Piletta di scarico
- Montaggio a parete
- Dimensioni standard:
  - larghezza 600 mm per posto
  - altezza 1200 mm
  - profondità 550 mm
- La finitura, le dimensioni del lavabo e gli accessori che lo compongono sono interamente personalizzabili a seconda delle esigenze di spazio e di utenze del cliente

- Surgical sink made of A304 stainless steel scotch-brite brushed finish
- antispash shaped sink treated
- corners with double folded edges cut resistant, ensuring a fast and easy cleaning
- mixer tap with manual clinic level, foot pedal or electronic by photocell control
- Removable front panel
- Available in one, two, three and four seats
- Accessories: dispensers disposable toothbrushes, liquid soap dispenser in stainless steel with push elbow or electronic, thermostatic temperature control device for optimal control of the water temperature
- Drain
- Wall assembling
- Standard dimensions:
  - 600 mm for seat width
  - 1200 mm height
  - 550 mm depth
- The finishing, the size of washbasin and accessories that make it up are fully personalized depending on the requirements of space and utilities of the customer

# Lavabo per chirurgo

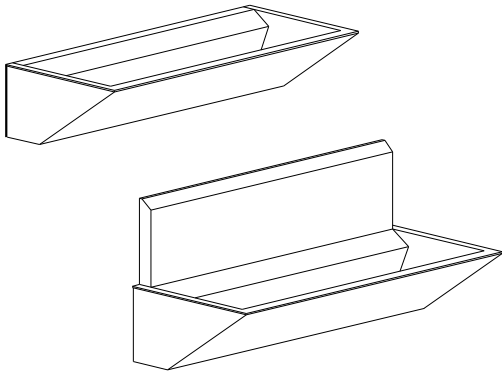
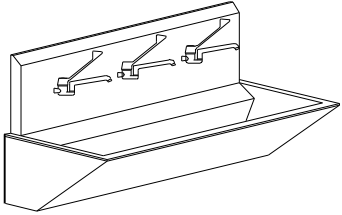
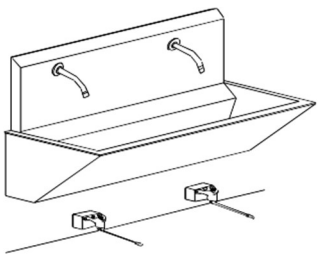
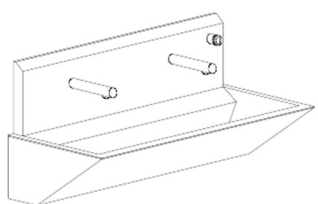
DESCRIZIONE	Dimensioni			Altre caratteristiche	CODICE
	L	P	H		
Lavabo per chirurgo senza rubinetteria 	600	550	600	s/paretina 1 posto	LC0605000S
	600	550	1200	c/paretina 1 posto	LC0605010S
	800	550	600	s/paretina 1 posto	LC0805000S
	800	550	1200	c/paretina 1 posto	LC0805010S
	1200	550	600	s/paretina 2 posti	LC1205000S
	1200	550	1200	c/paretina 2 posti	LC1205010S
	1800	550	600	s/paretina 3 posti	LC1805000S
	1800	550	1200	c/paretina 3 posti	LC1805010S
	2400	550	600	s/paretina 4 posti	LC2405000S
	2400	550	1200	c/paretina 4 posti	LC2405010S
Lavabo per chirurgo c/rubinetto a leva 	600	550	1200	c/paretina 1 posto	LC0605011S
	800	550	1200	c/paretina 1 posto	LC0805011S
	1200	550	1200	c/paretina 2 posti	LC1205011S
	1800	550	1200	c/paretina 3 posti	LC1805011S
	2400	550	1200	c/paretina 4 posti	LC2405011S
	2800	550	1200	c/paretina 4 posti	LC2805011S
Lavabo per chirurgo c/rubinetto a pedale 	600	550	1200	c/paretina 1 posto	LC0605012S
	800	550	1200	c/paretina 1 posto	LC0805012S
	1200	550	1200	c/paretina 2 posti	LC1205012S
	1800	550	1200	c/paretina 3 posti	LC1805012S
	2400	550	1200	c/paretina 4 posti	LC2405012S
	2800	550	1200	c/paretina 4 posti	LC2805012S
Lavabo per chirurgo c/rubinetto elettronico termostatico (alimentazione con pile/rete) 	600	550	1200	c/paretina 1 posto	LC0605013S
	800	550	1200	c/paretina 1 posto	LC0805013S
	1200	550	1200	c/paretina 2 posti	LC1205013S
	1800	550	1200	c/paretina 3 posti	LC1805013S
	2400	550	1200	c/paretina 4 posti	LC2405013S
Maggiorazione per miscelatore ON / OFF	0	0	0	cadauno	LC0005013S

# Lavabo per chirurgo

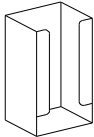
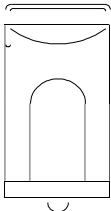
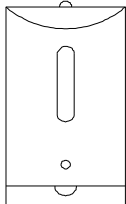
DESCRIZIONE	Dimensioni			Altre caratteristiche	CODICE
	L	P	H		
<p>Porta spazzolini</p> 	125	75	330	fissaggio a parete con viti	PS0000001S
<p>Dosatore di sapone liquido a leva</p> 	82	230	330	0,5 lt	DSLL00001S
	94	230	330	1,0 lt	DSLL10001S
<p>Dosatore di sapone liquido elettronico</p> 	118	110	260	con pompa peristaltica alimentazione da rete	DSLE00001S
	118	110	260	senza pompa peristaltica alimentazione a pile	DSLE00002S

# Arredamento sala operatoria

## TUNNEL PASSASPORCO

### Pass-dirty cabinet

TUNNEL PASSASPORCO interamente in acciaio inox AISI 304 finitura scotch-brite

- Chiuso perimetralmente, apribile da lato sporco / pulito mediante n. 2 ante a battente con guarnizione perimetrale antipolvere
  - ◻ Fondo liscio
  - ◻ Ante con interblocco elettrico che non consente l'apertura contemporanea delle porte lato sporco / pulito, in conformità con le norme in vigore
  - ◻ Sblocco porte mediante pulsante con spia luminosa verde / rosso
  - ◻ Montaggio su zoccolatura inox H 100 mm
  - ◻ Assenza di spigoli vivi e di tagli a contatto raggiungibili anche nelle operazioni di manutenzione e pulizia
  - ◻ Pannellature con superfici lisce, lavabili
  - ◻ Sportelli rivestiti con pannellature lato interno e tamburati
  - ◻ Fornibile anche nella versione con protezione anti RX
  - ◻ La finitura, le dimensioni e gli accessori che lo compongono sono interamente personalizzabili a seconda delle esigenze di spazio e di utenze del cliente
- 
- ◻ Pass-dirty cabinet made of A304 stainless steel scotch-brite brushed finish
  - ◻ Closed perimeter, opening from side clean / dirty by n. 2 hinged doors with anti-dust peripheral gasket
  - ◻ Smooth bottom
  - ◻ Doors with electrical interlock that prevents the simultaneous opening of the side door dirty / clean, according with rules currently in force
  - ◻ Unlock doors by push button with green / red warning light
  - ◻ Assembling on stainless steel base H 100 mm
  - ◻ No sharp edges and cuts in contact in maintenance and cleaning works
  - ◻ Panels with smooth washable surfaces
  - ◻ Doors covered with paneling inside and honeycomb
  - ◻ Also available in a version with anti RX protection

## FINESTRA PASSAFERRI

### Pass-through window

FINESTRA PASSAFERRI interamente in acciaio inox AISI 304 finitura scotch-brite

- ◻ Finestra saliscendi in vetro Visarm 8/9 scorrevole su guide antifregamento in nylon antipolvere autolubrificante per la silenziosità del meccanismo
  - ◻ Meccanismo di apertura / chiusura bilanciato a contrappeso per il posizionamento
  - ◻ Cornici inox di chiusura a parete perimetrale su ambedue i lati
  - ◻ Possibilità di posizionare la finestra sopra il passasporco
  - ◻ Assenza di spigoli vivi e di tagli a contatto raggiungibili anche nelle operazioni di manutenzione e pulizia
  - ◻ Fornibile anche nella versione con protezione anti RX
  - ◻ La finitura, le dimensioni e gli accessori che lo compongono sono interamente personalizzabili a seconda delle esigenze di spazio e di utenze del cliente
- 
- ◻ PASS-THROUGH WINDOW made of A304 stainless steel scotch-brite brushed finish
  - ◻ Latch window in Visarm glass 8/9 sliding on guides chafing in nylon anti-dust for self-lubricating mechanism
  - ◻ Mechanism for opening / closing counterweight balanced for positioning
  - ◻ Closing steel frames on both sides
  - ◻ Possibility to position the window over the pass-dirty cabinet
  - ◻ No sharp edges and cuts in contact reached also in the maintenance and cleaning works
  - ◻ Also available in a version with anti RX
  - ◻ The finish, sizes, and accessories that make it up are fully personalized according to the needs of space and loads of customer

## **PARETI TECNICHE ATTREZZATE**

### **Equipped theatres for operating rooms**

PARETI TECNICHE ATTREZZATE interamente in acciaio inox AISI 304 finitura scotch-brite

- Chiusa perimetralmente su tre lati con possibilità di allestire il frontale con le seguenti zone e servizi:
- Base a giorno o chiusa con ante a battenti in lamiera / vetro o in alternativa con cassetteria a più cassetti
- Vano catgutiera di deposito completa di cassetto estraibile o di pannello ribaltabile da utilizzare come scrittoio
- Vano con pannello predisposto con gas tecnici (O<sub>2</sub>, NO<sub>2</sub>, AC, ASP, ARIA COMPRESSA)
- Vano con pannello prese elettriche tipo Schuko
- Vano con negatoscopio completo di prese elettriche per i comandi
- Vano con orologio contasecondi
- Ante e cassetti dotati di guarnizioni silconiche perimetrali antipolvere
- Cassetti con guide telescopiche
- Maniglie in tondino
- Ripiani intermedi all'interno dei vani regolabili su cremagliere
- Assenza di spigoli vivi e di tagli a contatto raggiungibili anche nelle operazioni di manutenzione e pulizia
- Pannellature con superfici lisce, lavabili
- Sportelli rivestiti con pannellature lato interno e tamburati
- Realizzabili nella versione ad incasso a parete o posizionabili a pavimento su piedini regolabili in altezza o zoccolo fisso
- La finitura, le dimensioni e gli accessori che lo compongono sono interamente personalizzabili a seconda delle esigenze di spazio e di utenze del cliente

- EQUIPPED WALLS FOR OPERATING ROOMS made of A304 stainless steel scotch-brite brushed finish
- Perimetrically closed on three sides with possibility of setting the front zones with the following services:
- Open base or closed with sliding doors in sheet metal / glass or alternatively with drawers
- Cat-gut unit storage compartment complete with removable tray or hinged panel to use as a desk
- Compartment with connections for technical gases (O<sub>2</sub>, NO<sub>2</sub>, AC, ASP, COMPRESSED AIR)
- Compartment with panel Schuko sockets
- Negatoscope compartment with sockets for commands
- Compartment with stopwatch clock
- Doors and drawers with silicone perimeter seal anti-dust
- Drawers with telescopic rails
- Rounded handles
- Adjustable shelves
- No sharp edges and cuts in contact can also be reached in the maintenance and cleaning
- Panels with smooth surfaces, washable
- Doors covered with paneling inside and honeycomb
- Achievable in a version with built-in wall or floor positioned on adjustable feet or fixed base
- The finish, sizes, and accessories that make it up are fully customizable according to the needs of space and loads of customer

## **ARMADI CON GUARNIZIONI**

### **Cabinet with seal**

ARMADIO CON GUARNIZIONI interamente in acciaio inox AISI 304 finitura scotch-brite

- Chiusa perimetralmente su tre lati
- Ante in lamiera o con vetro temperato con guarnizioni silconiche perimetrali antipolvere
- Ripiani in lamiera o in vetro regolabili in altezza su cremagliere,
- Maniglie in tondino
- Assenza di spigoli vivi e di tagli a contatto raggiungibili anche nelle operazioni di manutenzione e pulizia
- Pannellature con superfici lisce, lavabili
- Sportelli rivestiti con pannellature lato interno e tamburati
- Modello standard con zoccolo fisso, realizzabile su richiesta con piedini regolabili in altezza e zoccolo amovibile con clip di incastro sui piedini
- Realizzabile a richiesta nella versione ad incasso
- La finitura, le dimensioni e gli accessori che lo compongono sono interamente personalizzabili a seconda delle esigenze di spazio e di utenze del cliente

- CABINET WITH SEALS made of A304 stainless steel scotch-brite brushed finish
- Perimetrically closed on three sides
- Doors with metal or tempered glass with silicone perimeter seal anti-dust
- Shelves in metal or glass adjustable height of racks,
- Rounded handles
- No sharp edges and cuts in contact can also be reached in the maintenance and cleaning
- Panels with smooth surfaces, washable
- Branches covered with paneling inside and honeycomb
- Standard model with fixed base, available for request with adjustable feet and removable base with clip snap on feet
- It can be produced on request in the built-in version

# Arredamento sala operatoria

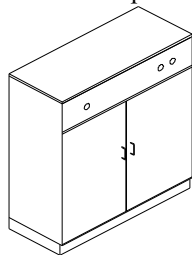
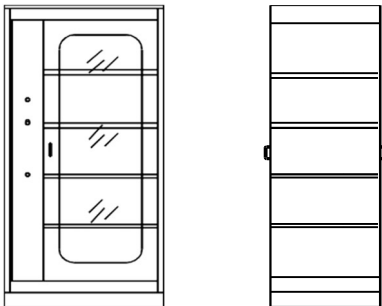
DESCRIZIONE	Dimensioni			Altre caratteristiche	CODICE
	L	P	H		
<b>Tunnel Passaporco</b> 	1000	500	1000	n. 2 ante cieche	TP1005000S
	1000	500	1000	anti X spessore 2 mm	TP1005001S
<b>Armadio Passante</b> 	1000	700	2000	n. 1 anta in vetro per lato	TP1007001V
	1200	700	2000	n. 2 ante in vetro per lato	TP1207002V
	1000	700	2000	n. 1 anta cieca per lato	TP1007001C
	1200	700	2000	n. 2 ante cieche per lato	TP1207002C
	1000	700	2000	anti X EQ2 n. 1 anta cieca per lato	TP1007001X
	1200	700	2000	anti X EQ2 n. 2 ante cieche per lato	TP1207002X
	1000	700	2000	n. 1 ante cieche anti X EQ2 n. 1 anta vetro	TP10070V1X
	1200	700	2000	n. 2 ante cieche anti X EQ2 n. 2 ante vetro	TP12070V2X

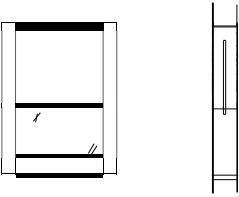
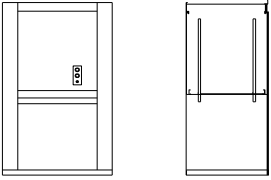
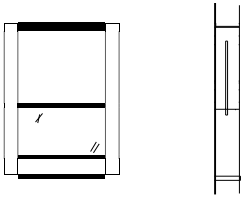

# Arredamento sala operatoria

DESCRIZIONE	Dimensioni			Altre caratteristiche	CODICE
	L	P	H		
<b>Finestra passaferrì</b> 	800	150	1400	comando manuale	FP0815000S
	800	150	1400	motorizzata	FP08150M0S
<b>Finestra passaferrì doppia con interblocco</b> 	800	700	1400	comando manuale	FP0807002S
	800	700	1400	motorizzata	FP08070M2S
<b>Finestra passaferrì (anti RX eq. 2)</b> 	800	150	1400	anti X eq. 2	FP0815RX2S

# Arredamento sala operatoria

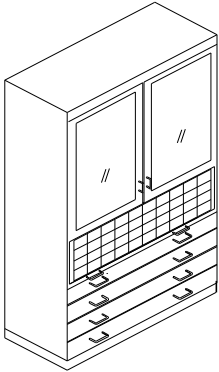
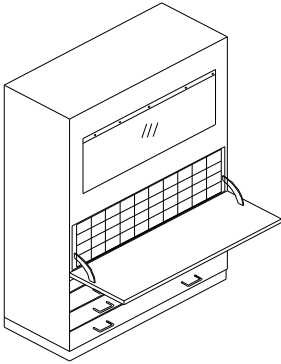
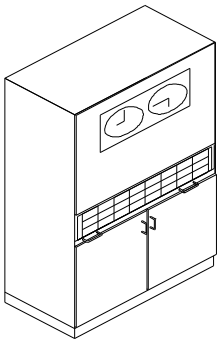
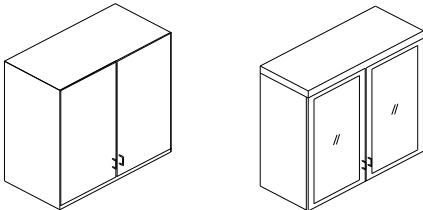
DESCRIZIONE	Dimensioni			Altre caratteristiche	CODICE
	L	P	H		
Parete tecnica attrezzata (cassettiera + catgutiera + vano con ante in vetro) 	1000	500	2000		PT1005CCVS
Parete tecnica attrezzata (cassettiera + catgutiera +negativoscopio) 	1000	500	2000		PT1005CCNS
Parete tecnica attrezzata (vano inferiore chiuso + catgutiera + orologio) 	1000	500	2000		PT1005LCNS
Modulo con ante a battente (n. 2 ripiani) 	1000	500	900	ante in lamiera	PT1005SL1S
	1000	500	900	ante in vetro	PT1005SV1S

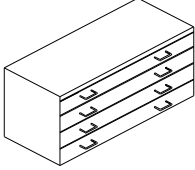
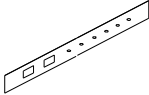
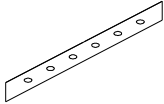
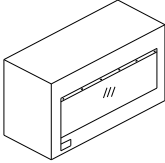
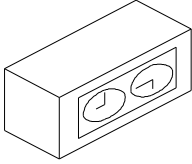
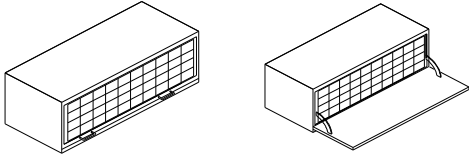
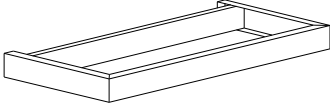

# Arredamento sala operatoria

DESCRIZIONE	Dimensioni			Altre caratteristiche	CODICE
	L	P	H		
<b>Modulo cassetiera</b> 	1000	500	800	4 cassette	PT1005IC1S
<b>Pannello prese elettriche (escluse prese)</b> 	1000	500	150		PT1005PE1S
<b>Pannello prese gas medicali (escluso prese)</b> 	1000	500	150		PT1005PG1S
<b>Modulo con negativotopio</b> 	1000	500	900		PT1005SN1S
<b>Modulo con orologio</b> 	1000	500	700	analogico	PT1005SOAS
	1000	500	700	digitale con tecnologia LED	PT1005SODS
<b>Modulo con catgutiera</b> 	1000	500	450	ribaltina / cassetto	PT1005CC1S
<b>Zoccolo inferiore</b> 	1000	500	150	fisso	ZI1005150S
	1000	500	150	asportabile	ZI100515AS

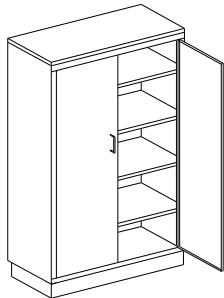
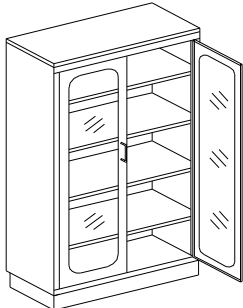
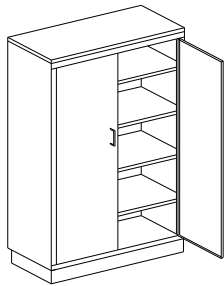
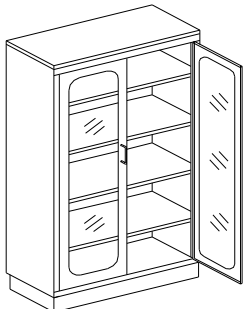

# Arredamento sala operatoria

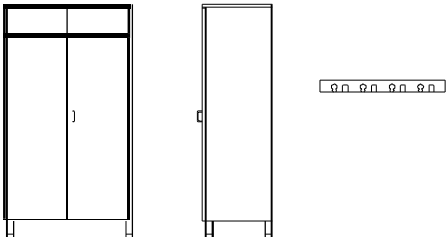
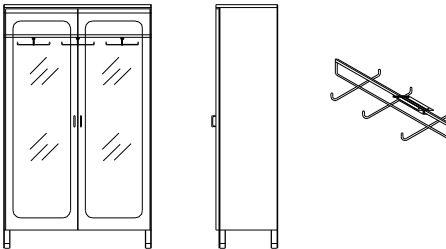
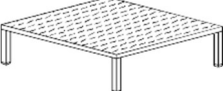
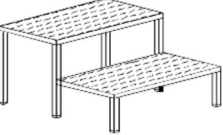
DESCRIZIONE	Dimensioni			Altre caratteristiche	CODICE
	L	P	H		
<p>Armadio con guarnizione antipolvere</p> 	600	500	2000	1 anta in lamiera n. 4 ripiani	AG06051LOS
	800	500	2000	2 ante in lamiera n. 4 ripiani	AG08052LOS
	1000	500	2000	2 ante in lamiera n. 4 ripiani	AG10052LOS
	1200	500	2000	2 ante in lamiera n. 4 ripiani	AG12052LOS
<p>Armadio con guarnizione antipolvere</p> 	600	500	2000	1 anta in vetro n. 4 ripiani	AG06051VOS
	800	500	2000	2 ante in vetro n. 4 ripiani	AG08052VOS
	1000	500	2000	2 ante in vetro n. 4 ripiani	AG10052VOS
	1200	500	2000	2 ante in vetro n. 4 ripiani	AG12052VOS
<p>Armadio con guarnizione antipolvere</p> 	600	700	2000	1 anta in lamiera n. 4 ripiani	AG06071LOS
	800	700	2000	2 ante in lamiera n. 4 ripiani	AG08072LOS
	1000	700	2000	2 ante in lamiera n. 4 ripiani	AG10072LOS
	1200	700	2000	2 ante in lamiera n. 4 ripiani	AG12072LOS
<p>Armadio con guarnizione antipolvere</p> 	600	700	2000	1 anta in vetro n. 4 ripiani	AG06071VOS
	800	700	2000	2 ante in vetro n. 4 ripiani	AG08072VOS
	1000	700	2000	2 ante in vetro n. 4 ripiani	AG10072VOS
	1200	700	2000	2 ante in vetro n. 4 ripiani	AG12072VOS

# Arredamento sala operatoria

DESCRIZIONE	Dimensioni			Altre caratteristiche	CODICE
	L	P	H		
Armadio portaendoscopi 	900	500	2000	ante in lamiera n. 4 endoscopi	AR09052LPE
	900	500	2000	ante in vetro n. 4 endoscopi	AR09052VPE
Armadio portacateteri 	1000	500	2000	ante in lamiera	AR10052LPC
	1000	500	2000	ante in vetro	AR10052VPC
Predellino ad 1 gradino 	600	650	220	piano antiscivolo	PR6065221G
Predellino a 2 gradini 	600	650	440	piano antiscivolo	PR6065222G
Tavolo servitore 	530	320	870 / 1200	regolazione manuale in altezza	TS533200RM
	800	500	870 / 1200	regolazione manuale in altezza	TS805000RM
Tavolo servitore 	800	500	870 / 1200	Pompa acciaio inox per regolazione in altezza	TS80500IRP
	800	500	870 / 1200	Pompa acciaio cromato per regolazione in altezza	TS80500CRP

# Arredamento sala operatoria

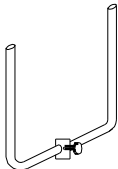
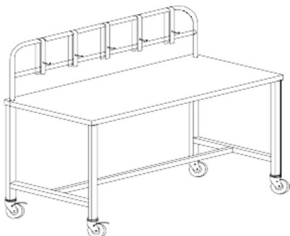
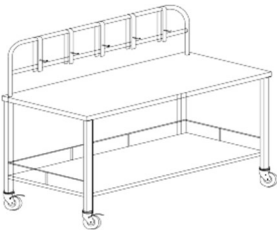
DESCRIZIONE	Dimensioni			Altre caratteristiche	CODICE
	L	P	H		
<p>Asta portaflebo</p> 	600	600	1600 / 2200	regolazione manuale in altezza	AF60604FRM
<p>Asta portaflebo</p> 	600	600	1350 / 2350	Pompa acciaio inox per regolazione in altezza	AF60604FRP
<p>Supporto pompa infusione</p> 	370	45	250	n. 4 pompe	AF37454PMA
<p>Tavolo madre per sala operatoria</p> 	1500	700	900	con telaio inferiore	TM1507G01S
<p>Tavolo madre per sala operatoria</p> 	1500	700	900	con ripiano inferiore	TM1507G02S

## Arredamento sala operatoria

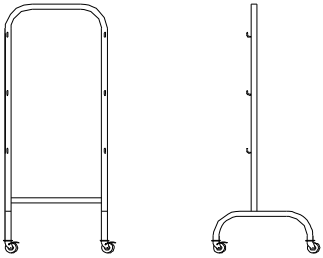
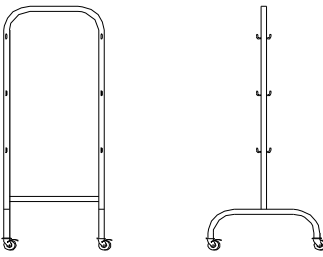
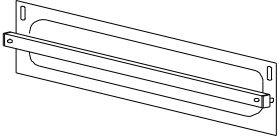
DESCRIZIONE	Dimensioni			Altre caratteristiche	CODICE
	L	P	H		
<p>Carrello porta accessori monofronte</p> 	555	500	1500		CA556215MO
<p>Carrello porta accessori bifronte</p> 	555	620	1500		CA555015BI
<p>Barra porta accessori</p> 	553	40	180		CA554018BA

# Arredamento sala lavaggio

## ARMADI E PENSILI PORTAPADELLE E PORTAPAPPAGALLI

Cabinet and wall cupboards for bedpans and urinals

ARMADIE PENSILI interamente in acciaio inox AISI 304 finitura scotch-brite

- Armadi chiusi con ante scorrevoli e dotati di:
  - Parete posteriore con ganci per padelle e pappagalli
  - Cestelli interni estraibili
  - Piano di fondo per fustini disinfettanti
  - Maniglie in tondino
  - Zoccolo inferiore
- Sopralzi aperti a giorno o chiusi con ante a battente / scorrevoli e dotati di:
  - Parete posteriore con ganci per padelle e pappagalli
  - Maniglie in tondino
  - vaschetta inferiore estraibile
  - staffa per fissaggio a parete
- Mensola a giorno dotata di
  - pannello posteriore con ganci per padelle e pappagalli
  - vaschetta inferiore asportabile
  - staffe per fissaggio a parete
  - Assenza di spigoli vivi e di tagli a contatto raggiungibili anche nelle operazioni di manutenzione e pulizia
- Pannellature con superfici lisce, lavabili
- Sportelli rivestiti con pannellature lato interno e tamburati
- La finitura, le dimensioni e gli accessori che lo compongono sono interamente personalizzabili a seconda delle esigenze di spazio e di utenze del cliente

- STRUCTURE made of A304 stainless steel scotch-brite brushed finish
- Cabinets closed with sliding doors and equipped with:
  - rear panel with hooks for bedpans and urinals
  - pull-out wire baskets
  - bottom shelf for disinfectants cans
  - rounded handles
  - lower base
- Raising open without doors or closed with hinged / sliding doors and equipped with:
  - rear panel with hooks for bedpans and urinals
  - rounded handles
  - Removable bottom tray
  - bracket for wall mounting
- Shelf with:
  - rear panel with hooks for bedpans and urinals
  - Removable lower tray
  - brackets for wall mounting
- No sharp edges and cut points can also be reached in the maintenance and cleaning operations
- Panels with smooth surfaces, washable
- Branches covered with paneling inside and honeycomb

## VUOTATOIO

### Slop sink

VUOTATOIO interamente in acciaio inox AISI 304 finitura scotch-brite

- Vasca centrale stampata con foro di scarico diam. 100 mm corredata di ugelli sciacquatori in acciaio inox
- Griglia asportabile posizionata sulla vasca in tondino inox diam. 10 mm
- Pulsante di comando per erogazione acqua con miscelatore temporizzato per getti di risciacquo
- Struttura perimetrale in acciaio inox con pannello frontale asportabile fissato con viti
- Possibilità di disporre lateralmente al vuotatoio un lavello con vasca dim. 330x330 mm con miscelatore dotato di comando a leva lunga
- Assenza di spigoli vivi e di tagli a contatto raggiungibili anche nelle operazioni di manutenzione e pulizia
- Pannellature con superfici lisce, lavabili
- Sportelli rivestiti con pannellature lato interno e tamburati
- La finitura, le dimensioni e gli accessori che lo compongono sono interamente personalizzabili a seconda delle esigenze di spazio e di utenze del cliente

- SLOP SINK made of A304 stainless steel scotch-brite brushed finish
- Central basin printed with drain hole diam. 100 mm equipped with stainless steel nozzles
- Removable grill
- Command button to dispense water mixer with timed rinsing spray
- Perimeter structure made of stainless steel with removable front panel secured with screws
- Possibility of having the side of the slop sink with a sink cupboard
- No sharp edges and cuts in contact can also be reached in the maintenance and cleaning
- Panels with smooth surfaces, washable
- Doors covered with paneling inside and honeycomb
- The finish, size, and accessories that make it up are fully customizable according to the needs of space and loads of

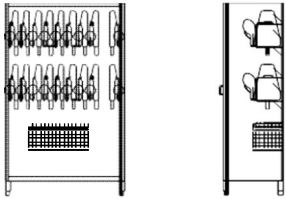
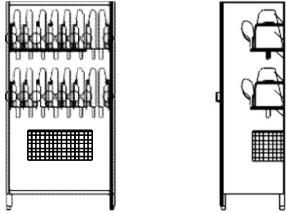
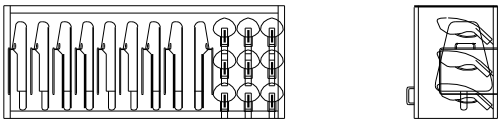
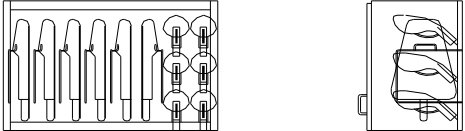
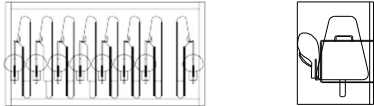
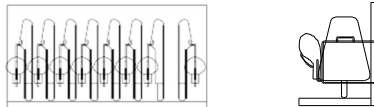

# Arredamento sala lavaggio

DESCRIZIONE	Dimensioni			Altre caratteristiche	CODICE
	L	P	H		
<b>Armadio deposito padelle ante scorrevoli</b> 	1000	600	2000	16+16	AP1006100S
	1200	600	2000	18+18	AP1206100S
<b>Armadio deposito padelle ante a battente</b> 	800	600	2000	12+12	AP0806200S
	1000	600	2000	16+16	AP1006200S
	1200	600	2000	18+18	AP1206200S
<b>Pensile portapadelle e portapappagalli ad ante scorrevoli</b> 	900	400	600	6+6	PP0904100S
	1350	400	600	9+9	PP1304100S
	1800	400	600	12+12	PP1804100S
<b>Pensile portapadelle e portapappagalli ad ante a battente</b> 	900	400	600	6+6	PP0904200S
	1350	400	600	9+9	PP1304200S
<b>Pensile portapadelle e portapappagalli a giorno</b> 	900	400	600	7+7	PP0904300S
	1350	400	600	11+11	PP1304300S
	1800	400	600	15+15	PP1804300S
<b>Mensola portapadelle e portapappagalli</b> 	900	400	600	7+7	PP0904400S
	1350	400	600	11+11	PP1304400S
	1800	400	600	15+15	PP1804400S

# Arredamento sala lavaggio

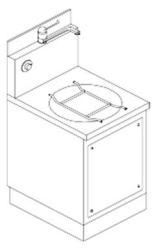
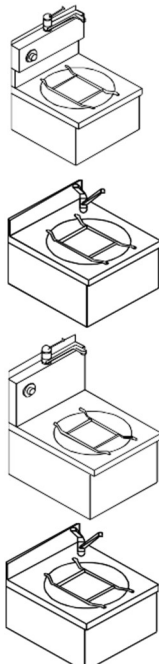
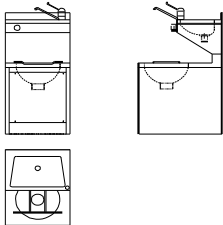
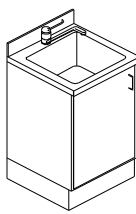
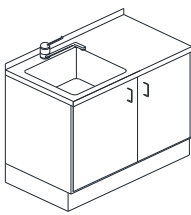
DESCRIZIONE	Dimensioni			Altre caratteristiche	CODICE
	L	P	H		
<b>Vuotoio su basamento</b> 	450	470	610	temporizzatore + miscelatore	VU454700BT
	450	570	610	temporizzatore + miscelatore	VU455700BT
<b>Vuotoio sospeso</b> 	450	470	350	temporizzatore + miscelatore	VU454700ST
	450	470	350	rubinetto di risciacquo	VU454700SR
	450	570	350	temporizzatore + miscelatore	VU455700ST
	450	570	350	rubinetto di risciacquo	VU455700SR
<b>Vuotoio combinato</b> 	500	650	900	temporizzatore + miscelatore	VU506500BT
<b>Banco lavello</b> 	450	470	900	vasca 330x330x200H miscelatore a leva	BL4547000S
	450	570	900	vasca 330x330x200H miscelatore a leva	BL4557000S
<b>Banco lavello</b> 	900	470	900	vasca 330x330x200H miscelatore a leva	BL9047000S
	900	570	900	vasca 330x330x200H miscelatore a leva	BL9057000S

# Sterilizzazione

## **BANCO LAVAGGIO AD ULTRASUONI**

### Ultrasonic washing bench

BANCO LAVAGGIO AD ULTRASUONI interamente in acciaio inox AISI 304 finitura scotch-brite

- Vasca ad ultrasuoni da 18 lt o in alternativa da 28, ad incasso, digitale, degas, sweep-system, timer e temperatura programmabile scarico liquido
- Fornita nella versione singola su mobiletto o montata su banco lavello (Dim.: 600x500x250 h) + doccia per aria (n. 1) ed acqua (n. 2)
- Armadio chiuso lateralmente ed aperto posteriormente per fissaggio collegamenti aria-acqua, chiuso anteriormente con sportelli ad ante scorrevoli
- Manici in tondino
- Modello standard poggiante su zoccolo fisso, su richiesta fornibile montato su piedini regolabili in altezza e zoccolo asportabile con clip di fissaggio ai piedini
- Assenza di spigoli vivi e di tagli a contatto raggiungibili anche nelle operazioni di manutenzione e pulizia
- Pannellature con superfici lisce, lavabili
- Sportelli rivestiti con pannellature lato interno e tamburati
- La finitura, le dimensioni e gli accessori che lo compongono sono interamente personalizzabili a seconda delle esigenze di spazio e di utenze del cliente

- STRUCTURE made of A304 stainless steel scotch-brite brushed finish
- Ultrasonic bath for 18 lt or, alternatively 28 lt
- Supplied in single cabinet or mounted on bench with sink (Dim.: 600x500x250 h) + air shower (no. 1) and water (no. 2)
- Closed cabinet sides and open at the rear to fix the air-water connections, closed front with sliding doors
- Handles rod
- Standard model resting on a base fixed, if request supplied mounted on adjustable feet and removable base with clip to the legs
- No sharp edges and cut points can also be reached in the maintenance and cleaning operations
- Panels with smooth surfaces, washable
- Branches covered with paneling inside and honeycomb
- The finish, size, and accessories that make it up are fully customizable according to the needs of space and loads of customer

## **CARRELLI PORTACONTAINER**

### Trolleys for container

CARRELLI PORTACONTAINER interamente in acciaio inox AISI 304 finitura scotch-brite

- STRUTTURA interamente in acciaio inox AISI 304 finitura scotch-brite
- Chiuso perimetralmente su tre lati
- Chiuso frontalmente con n. 2 ante a battente cieche con guarnizioni siliconiche antipolvere
- ripiani interni regolabili in altezza su cremagliere ed atti a contenere container da mm 600x300x300H
- montato su n. 4 ruote piroettanti di cui n. 2 con freno
- maniglione direzionale e paracolpi in gomma sui quattro lati
- Assenza di spigoli vivi e di tagli a contatto raggiungibili anche nelle operazioni di manutenzione e pulizia
- Pannellature con superfici lisce, lavabili
- La finitura, le dimensioni e gli accessori che lo compongono sono interamente personalizzabili a seconda delle esigenze di spazio e di utenze del cliente

- STRUCTURE made of A304 stainless steel scotch-brite brushed finish
- Perimetrically closed on three sides
- Closed frontally with n. 2 hinged doors with silicone gaskets antidust
- Internal shelves adjustable in height on racks and suitable to contain container mm 600x300x300H
- Mounted on n. 4 castors of which no. 2 with brakes
- Directional handle and rubber bumpers on all four sides
- Panels with smooth surfaces, washable
- The finish, size, and accessories that make it up are fully customizable according to the needs of space and loads of customer

# Sterilizzazione

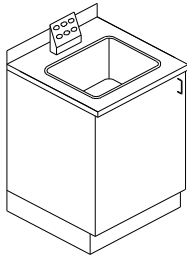
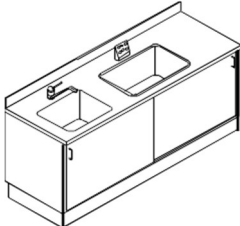
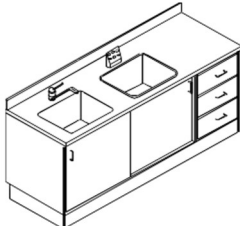
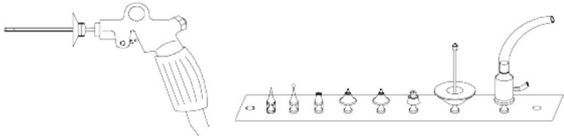
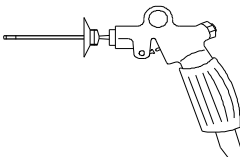
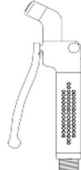
DESCRIZIONE	Dimensioni			Altre caratteristiche	CODICE
	L	P	H		
Banco Lavaggio ad ultrasuoni 	600	700	900	vasca 18 lt 330x300x200h	BL06071800
	800	700	900	vasca 28 lt 500x300x200h	BL08072800
Banco Lavaggio ad ultrasuoni con lavello 	2000	700	900	vasca 28 lt 500x300x200h lavello 500x400x250h	BL200728V0
Banco Lavaggio ad ultrasuoni con lavello e cassetiera 	2500	700	900	vasca 28 lt 500x300x200h lavello 500x400x250h	BL250728VA
Pistola di lavaggio acqua/aria completa di n. 8 ugelli 	0	0	0		PLAA00001S
Pistola di asciugatura ad aria compressa 	0	0	0		PAAC00001S
Doccetta lavaggio 	0	0	0		DL0000001S

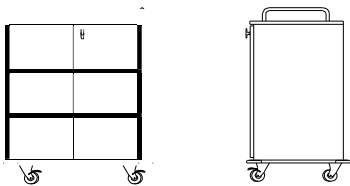
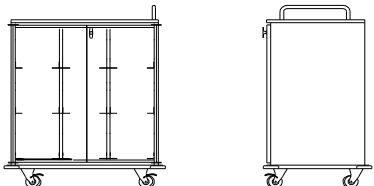
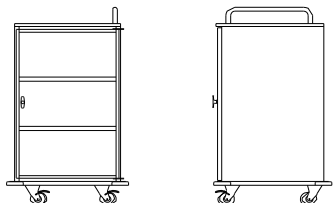
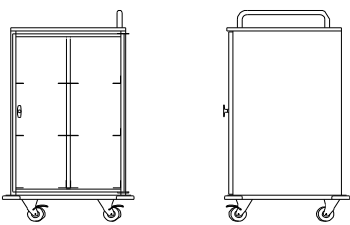
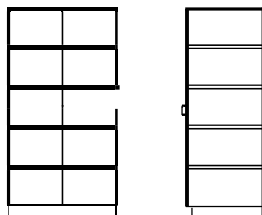
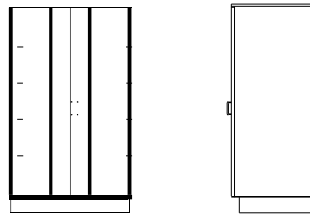

# Sterilizzazione

DESCRIZIONE	Dimensioni			Altre caratteristiche	CODICE
	L	P	H		
<p>Carrello portacontainers a 9 posti</p> 	1120	780	1450	n. 2 ripiani	CA1108PC9P
<p>Carrello portacontainers a 9 posti</p> 	1156	780	1450	n. 9 coppie angolari supporti containers	CA1108AC9P
<p>Carrello portacontainers a 6 posti</p> 	800	780	1450	n. 2 ripiani	CA0808PC6P
<p>Carrello portacontainers a 6 posti</p> 	817	780	1450	n. 6 coppie angolari supporti containers	CA0808AC6P
<p>Armadio portacontainers</p> 	1000	700	2000	n. 4 ripiani capacità n. 15 containers	AG10072LPC
<p>Armadio portacontainers</p> 	1054	700	2000	n. 15 coppie angolari fissi	AG10072LAC

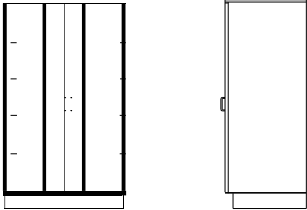
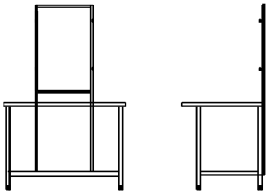
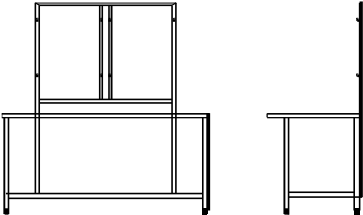
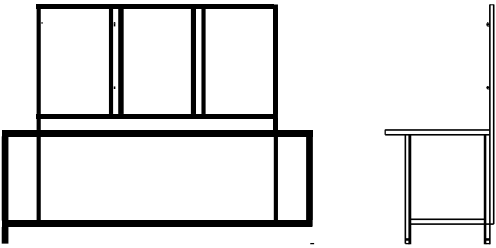
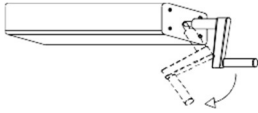
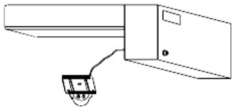
# Sterilizzazione

DESCRIZIONE	Dimensioni			Altre caratteristiche	CODICE
	L	P	H		
<p>Armadio portacontainers</p> 	1138	700	2000	n. 15 coppie angolari su guide ad estrazione totale	AG10072GAC
<p>Tavolo confezionamento 1 campata</p> 	1200	800	1900	ripiano inferiore	TC090800ST
<p>Tavolo confezionamento 2 campate</p> 	1800	800	1900	ripiano inferiore	TC150800ST
<p>Tavolo confezionamento 3 campate</p> 	2400	800	1900	ripiano inferiore	TC210800ST
<p>Accessori per regolazione manuale altezza tavoli</p> 	0	0	0/400	n. 4 pistoni oleodinamici	TC04004PRM
<p>Accessori per regolazione motorizzata altezza tavoli</p> 	0	0	0/400	n. 4 pistoni oleodinamici	TC04004PRE

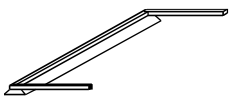
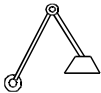
# Sterilizzazione

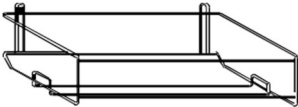
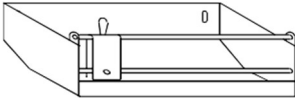
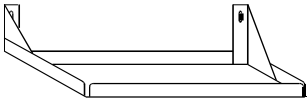
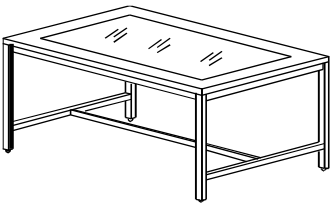
DESCRIZIONE	Dimensioni			Altre caratteristiche	CODICE
	L	P	H		
Lampada illuminazione tavolo 	0	0	0		TC000000NE
Lampada con lente ingrandimento 	0	0	0	5 diottrie - 1x8 W	TC050800LI
Cestello 	600	300	300	filo 6	TC060306CE
	600	300	150	filo 6	TC060315CE
Porta rotoli 	630	270	200		TC632720PR
Porta rotoli con taglierina 	630	375	300		TC633730TA
Mensola 	630	350	170		TC633517ME
Tavolo controllo tessuti 	1200	700	900		TC120709CT
	2000	900	900		TC200909CT

# Arredi neutri

## LAVELLO SALA GESSI Sink plaster room

LAVELLO SALA GESSI interamente in acciaio inox AISI 304 finitura scotch-brite

- ▣ Top superiore con n. 2 vasche , n. 1 dim. 500x400x300h, n. 1 dim. 500x500x200h e dotata di vaschetta interna diam. 160 mm con cestello forato estraibile.
- ▣ Armadio chiuso lateralmente ed aperto posteriormente per fissaggio collegamenti aria-acqua, chiuso anteriormente con sportelli ad ante scorrevoli
- ▣ Disponibile anche nella versione con cassettera a tre cassetti posti su guide ad estrazione totale
- ▣ Manici in tondino
- ▣ Modello standard poggiante su zoccolo fisso, su richiesta fornibile montato su piedini regolabili in altezza e zoccolo asportabile con clip di fissaggio ai piedini
- ▣ Assenza di spigoli vivi e di tagli a contatto raggiungibili anche nelle operazioni di manutenzione e pulizia
- ▣ Pannellature con superfici lisce, lavabili
- ▣ Sportelli rivestiti con pannellature lato interno tamburati
- ▣ La finitura, le dimensioni e gli accessori che lo compongono sono interamente personalizzabili a seconda delle esigenze di spazio e di utenze del cliente

- ▣ STRUCTURE made of A304 stainless steel scotch-brite brushed finish
- ▣ Upper top with n. 2 baths, no. 1 dim. 500x400x300h, n. 1 dim. 500x500x200h and features an inner bowl diameter. 160 mm with removable perforated basket.
- ▣ Closed cabinet sides and open at the rear to fix the air-water connections, closed front with sliding doors
- ▣ Also available with triple drawer set on full extension slides
- ▣ Handles rod
- ▣ Standard model resting on a base fixed on request supplied mounted on adjustable feet and removable base with clip to the legs
- ▣ No sharp edges and cut points can also be reached in the maintenance and cleaning operations
- ▣ Panels with smooth surfaces, washable

## Lavello sala gessi

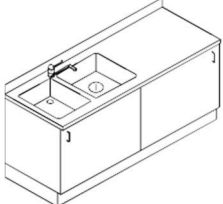
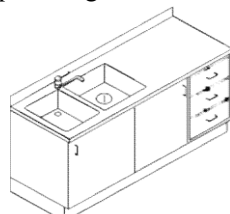
DESCRIZIONE	Dimensioni			Altre caratteristiche	CODICE
	L	P	H		
<p>Lavello per sala gessi</p> 	2000	700	850		LG20072V0S
<p>Lavello per sala gessi con cassettera</p> 	2000	700	850		LG20072V1S



# Arredamento deposito salme

## CARRELLI PORTASALME

Remains trolleys

- CARRELLO PORTASALME interamente in acciaio inox AISI 304 finitura scotch-brite
  - Piano superiore inclinato con sagomatura verso foro scarico liquami
  - Coperchio superiore con asole di aerazione e maniglie in tondino di acciaio per movimentazione
    - Struttura portante in tubolare
  - N. 4 ruote girevoli diam. 125 di cui n. 2 con freno
  - Vasca asportabile di raccolta liquame
  - Assenza di spigoli vivi e di tagli a contatto raggiungibili anche nelle operazioni di manutenzione e pulizia
- 
- STRUCTURE made of A304 stainless steel scotch-brite brushed finish
  - Upper floor with sloping shape sewage to drain hole
  - Top cover with ventilation slots and handles in steel rod for moving
  - Supporting frame in tubular element

## Arredi deposito salme

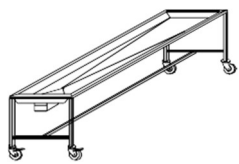
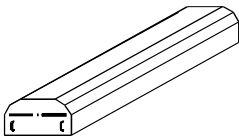
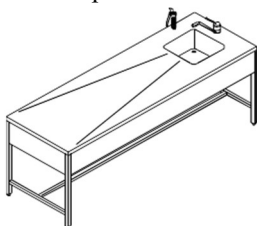
DESCRIZIONE	Dimensioni			Altre caratteristiche	CODICE
	L	P	H		
Carrello portasalme 	2060	700	750	barella saldata alla struttura	TAPS2070BF
	2060	700	750	barella asportabile	TAPS2070BA
Coperchio carrello portasalme 	2060	700	400		TAPS2070CO
Tavolo autopsia 	2800	800	900	vasca quadra 400x400x250H	TAAU287000

# Arredi neutri

## TAVOLI SU GAMBE

### Tables on legs

TAVOLI SU GAMBE interamente in acciaio inox AISI 304 finitura scotch-brite

- Piano di lavoro spessore 40 mm con piega salvamani sui bordi
- Alzatina posteriore paraspruzzi H100 mm (se presente)
- Gambe in tubolare quadro 40x40 dotate di piedini regolabili in altezza in modo da garantire un perfetto allineamento con il pavimento
- Possibilità di accessorizzare i tavoli con n. 1 cassetto singolo, cassetiera a 2 o più cassetti, ruote per la movimentazione
- Adatti per uso sanitario
- Profondità 600 o 700 mm
- Dotati di telaio o di ripiano di fondo
- Assenza di spigoli vivi e di tagli a contatto raggiungibili anche nelle operazioni di manutenzione e pulizia
- Pannellature con superfici lisce, lavabili
- La finitura, le dimensioni e gli accessori che lo compongono sono interamente personalizzabili a seconda delle esigenze di spazio e di utenze del cliente

- STRUCTURE made of A304 stainless steel scotch-brite brushed finish
- Worktop thickness 40 mm with upturned edges
- Rear upstand H100 mm (if present)
- Tubular legs 40x40 framework equipped with height-adjustable feet so as to ensure a perfect alignment with the floor
- Possibility of accessorise the tables with n. 1 single drawer, chest of drawers with 2 or more drawers, wheels for moving
- Suitable for sanitary use
- Depth 600 or 700 mm
- Equipped with frame or bottom shelf
- No sharp edges and cut points can also be reached in the maintenance and cleaning operations
- Panels with smooth surfaces, washable
- The finish, size, and accessories that make it up are fully customizable according to the needs of space and loads of customer
- STRUCTURE made of A304 stainless steel scotch-brite brushed finish
- Upper floor with sloping shape sewage to drain hole
- Top cover with ventilation slots and handles in steel rod for moving
- Supporting frame in tubolare
- N. 4 swivel castors diam. 125, n. 2 with brakes
- Removable tank for sewage
- No sharp edges and cut points can also be reached in the maintenance and cleaning operations

# Tavoli su gambe

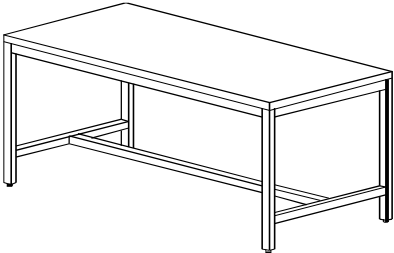
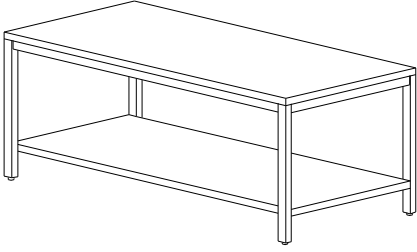
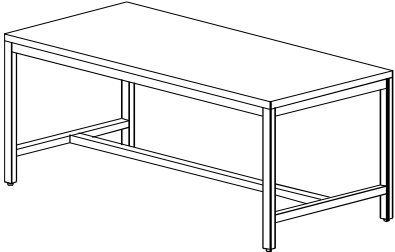
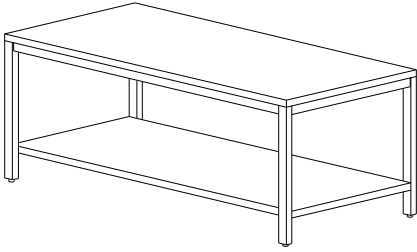
DESCRIZIONE	Dimensioni			Altre caratteristiche	CODICE
	L	P	H		
<p>Tavolo su gambe con telaio</p> 	1000	600	850	4 gambe	TA1006GT0S
	1100	600	850	4 gambe	TA1106GT0S
	1200	600	850	4 gambe	TA1206GT0S
	1300	600	850	4 gambe	TA1306GT0S
	1400	600	850	4 gambe	TA1406GT0S
	1500	600	850	4 gambe	TA1506GT0S
	1600	600	850	4 gambe	TA1606GT0S
	1700	600	850	4 gambe	TA1706GT0S
	1800	600	850	4 gambe	TA1806GT0S
	1900	600	850	4 gambe	TA1906GT0S
	2000	600	850	4 gambe	TA2006GT0S
<p>Tavolo su gambe con ripiano</p> 	1000	600	850	4 gambe	TA1006RT0S
	1100	600	850	4 gambe	TA1106RT0S
	1200	600	850	4 gambe	TA1206RT0S
	1300	600	850	4 gambe	TA1306RT0S
	1400	600	850	4 gambe	TA1406RT0S
	1500	600	850	4 gambe	TA1506RT0S
	1600	600	850	4 gambe	TA1606RT0S
	1700	600	850	4 gambe	TA1706RT0S
	1800	600	850	4 gambe	TA1806RT0S
	1900	600	850	4 gambe	TA1906RT0S
	2000	600	850	4 gambe	TA2006RT0S
<p>Tavolo su gambe con telaio</p> 	1000	700	850	4 gambe	TA1007GT0S
	1100	700	850	4 gambe	TA1107GT0S
	1200	700	850	4 gambe	TA1207GT0S
	1300	700	850	4 gambe	TA1307GT0S
	1400	700	850	4 gambe	TA1407GT0S
	1500	700	850	4 gambe	TA1507GT0S
	1600	700	850	4 gambe	TA1607GT0S
	1700	700	850	4 gambe	TA1707GT0S
	1800	700	850	4 gambe	TA1807GT0S
	1900	700	850	4 gambe	TA1907GT0S
	2000	700	850	4 gambe	TA2007GT0S
<p>Tavolo su gambe con ripiano</p> 	1000	700	850	4 gambe	TA1007RT0S
	1100	700	850	4 gambe	TA1107RT0S
	1200	700	850	4 gambe	TA1207RT0S
	1300	700	850	4 gambe	TA1307RT0S
	1400	700	850	4 gambe	TA1407RT0S
	1500	700	850	4 gambe	TA1507RT0S
	1600	700	850	4 gambe	TA1607RT0S
	1700	700	850	4 gambe	TA1707RT0S
	1800	700	850	4 gambe	TA1807RT0S
	1900	700	850	4 gambe	TA1907RT0S
	2000	700	850	4 gambe	TA2007RT0S

# Tavoli su gambe

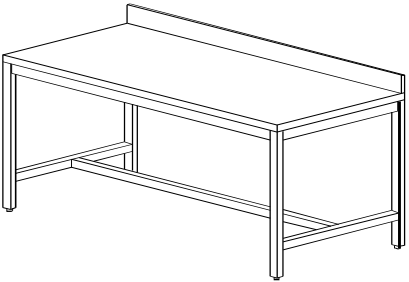
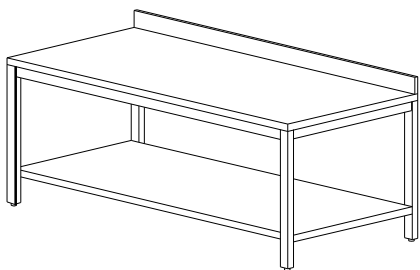
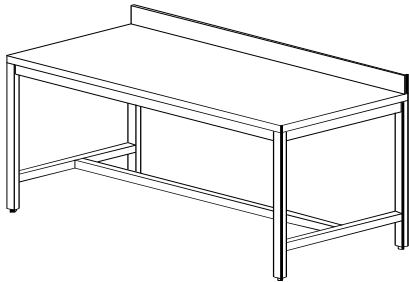
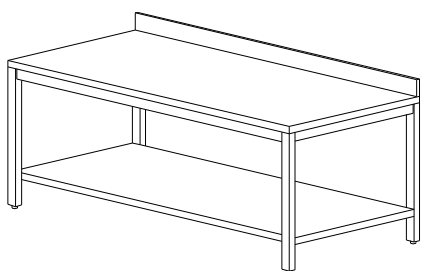
DESCRIZIONE	Dimensioni			Altre caratteristiche	CODICE
	L	P	H		
<p>Tavolo su gambe con telaio e alzatina</p> 	1000	600	850	4 gambe	TA1006GTAS
	1100	600	850	4 gambe	TA1106GTAS
	1200	600	850	4 gambe	TA1206GTAS
	1300	600	850	4 gambe	TA1306GTAS
	1400	600	850	4 gambe	TA1406GTAS
	1500	600	850	4 gambe	TA1506GTAS
	1600	600	850	4 gambe	TA1606GTAS
	1700	600	850	4 gambe	TA1706GTAS
	1800	600	850	4 gambe	TA1806GTAS
	1900	600	850	4 gambe	TA1906GTAS
	2000	600	850	4 gambe	TA2006GTAS
<p>Tavolo su gambe con ripiano e alzatina</p> 	1000	600	850	4 gambe	TA1006RTAS
	1100	600	850	4 gambe	TA1106RTAS
	1200	600	850	4 gambe	TA1206RTAS
	1300	600	850	4 gambe	TA1306RTAS
	1400	600	850	4 gambe	TA1406RTAS
	1500	600	850	4 gambe	TA1506RTAS
	1600	600	850	4 gambe	TA1606RTAS
	1700	600	850	4 gambe	TA1706RTAS
	1800	600	850	4 gambe	TA1806RTAS
	1900	600	850	4 gambe	TA1906RTAS
	2000	600	850	4 gambe	TA2006RTAS
<p>Tavolo su gambe con telaio e alzatina</p> 	1000	700	850	4 gambe	TA1007GTAS
	1100	700	850	4 gambe	TA1107GTAS
	1200	700	850	4 gambe	TA1207GTAS
	1300	700	850	4 gambe	TA1307GTAS
	1400	700	850	4 gambe	TA1407GTAS
	1500	700	850	4 gambe	TA1507GTAS
	1600	700	850	4 gambe	TA1607GTAS
	1700	700	850	4 gambe	TA1707GTAS
	1800	700	850	4 gambe	TA1807GTAS
	1900	700	850	4 gambe	TA1907GTAS
	2000	700	850	4 gambe	TA2007GTAS
<p>Tavolo su gambe con ripiano e alzatina</p> 	1000	700	850	4 gambe	TA1007RTAS
	1100	700	850	4 gambe	TA1107RTAS
	1200	700	850	4 gambe	TA1207RTAS
	1300	700	850	4 gambe	TA1307RTAS
	1400	700	850	4 gambe	TA1407RTAS
	1500	700	850	4 gambe	TA1507RTAS
	1600	700	850	4 gambe	TA1607RTAS
	1700	700	850	4 gambe	TA1707RTAS
	1800	700	850	4 gambe	TA1807RTAS
	1900	700	850	4 gambe	TA1907RTAS
	2000	700	850	4 gambe	TA2007RTAS

# Arredi neutri

## **BANCHI ARMADIATI**

### **Table cupboard**

BANCHI ARMADIATI interamente in acciaio inox AISI 304 finitura scotch-brite

- Piano di lavoro spessore 40 mm con piega salvamani sui bordi
- Alzatina posteriore paraspruzzi H100 mm (se presente)
- Gambe regolabili in altezza (60 mm) in modo da garantire un perfetto allineamento con il pavimento e con gli altri elementi presenti nel locale
- Possibilità di accessoriare i tavoli con: cassetti orizzontali, cassetiera a 2 o più cassetti, ruote per la movimentazione
- Adatti per uso sanitario
- Profondità 600 o 700 mm
- Manici in tondino
- Assenza di spigoli vivi e di tagli a contatto raggiungibili anche nelle operazioni di manutenzione e pulizia
- Pannellature con superfici lisce, lavabili
- Sportelli rivestiti con pannellature lato interno e tamburati
- La finitura, le dimensioni e gli accessori che lo compongono sono interamente personalizzabili a seconda delle esigenze di spazio e di utenze del cliente

◦ STRUCTURE made of A304 stainless steel scotch-brite brushed finish

- Worktop thickness 40 mm with upturned edges
- Rear upstand H100 mm (if present)
- Legs adjustable in height (60 mm) so as to ensure a perfect alignment with the floor and the other elements present in the local
- Ability to accessorize tables: drawers, wheels for moving
- Suitable for sanitary use
- Depth 600 or 700 mm
- Handles rod
- No sharp edges and cut points can also be reached in the maintenance and cleaning operations
- Panels with smooth surfaces, washable
- Branches covered with paneling inside and honeycomb
- The finish, size, and accessories that make it up are fully customizable according to the needs of space and loads of customer

# Banchi armadiati

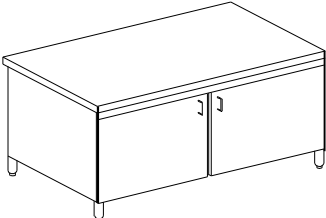
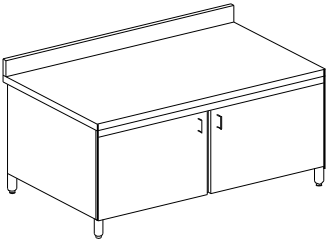
DESCRIZIONE	Dimensioni			Altre caratteristiche	CODICE
	L	P	H		
<p>Banco armadiato porta a battente</p> 	700	600	850	1 porta	TA0706PB0S
	800	600	850	2 porte	TA0806PB0S
	900	600	850	2 porte	TA0906PB0S
	1000	600	850	2 porte	TA1006PB0S
	700	700	850	1 porta	TA0707PB0S
	800	700	850	2 porte	TA0807PB0S
	900	700	850	2 porte	TA0907PB0S
	1000	700	850	2 porte	TA1007PB0S
<p>Banco armadiato porta a battente con alzatina</p> 	700	600	850	1 porta	TA0706PBAS
	800	600	850	2 porte	TA0806PBAS
	900	600	850	2 porte	TA0906PBAS
	1000	600	850	2 porte	TA1006PBAS
	700	700	850	1 porta	TA0707PBAS
	800	700	850	2 porte	TA0807PBAS
	900	700	850	2 porte	TA0907PBAS
	1000	700	850	2 porte	TA1007PBAS

# Banchi armadiati

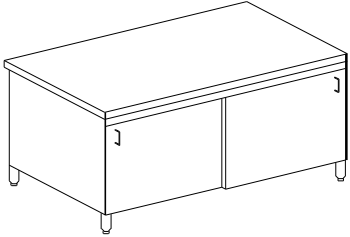
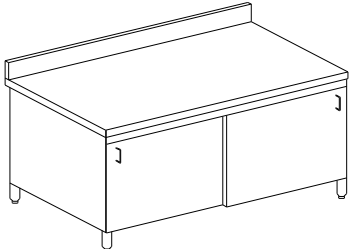

DESCRIZIONE	Dimensioni			Altre caratteristiche	CODICE
	L	P	H		
<p>Banco armadiato porte scorrevoli</p> 	1200	600	850	4 gambe	TA1206PS0S
	1300	600	850	4 gambe	TA1306PS0S
	1400	600	850	4 gambe	TA1406PS0S
	1500	600	850	4 gambe	TA1506PS0S
	1600	600	850	4 gambe	TA1606PS0S
	1700	600	850	4 gambe	TA1706PS0S
	1800	600	850	4 gambe	TA1806PS0S
	1900	600	850	4 gambe	TA1906PS0S
	2000	600	850	4 gambe	TA2006PS0S
	2100	600	850	4 gambe	TA2106PS0S
	2200	600	850	4 gambe	TA2206PS0S
	2300	600	850	6 gambe	TA2306PS0S
	2400	600	850	6 gambe	TA2406PS0S
	2500	600	850	6 gambe	TA2506PS0S
	2600	600	850	6 gambe	TA2606PS0S
<p>Banco armadiato porte scorrevoli con alzatina</p> 	1200	600	850	4 gambe	TA1206PSAS
	1300	600	850	4 gambe	TA1306PSAS
	1400	600	850	4 gambe	TA1406PSAS
	1500	600	850	4 gambe	TA1506PSAS
	1600	600	850	4 gambe	TA1606PSAS
	1700	600	850	4 gambe	TA1706PSAS
	1800	600	850	4 gambe	TA1806PSAS
	1900	600	850	4 gambe	TA1906PSAS
	2000	600	850	4 gambe	TA2006PSAS
	2100	600	850	4 gambe	TA2106PSAS
	2200	600	850	4 gambe	TA2206PSAS
	2300	600	850	6 gambe	TA2306PSAS
	2400	600	850	6 gambe	TA2406PSAS
	2500	600	850	6 gambe	TA2506PSAS
	2600	600	850	6 gambe	TA2606PSAS

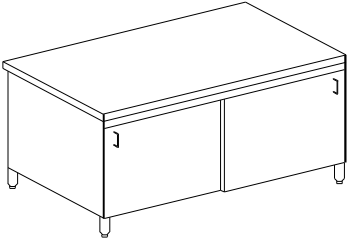
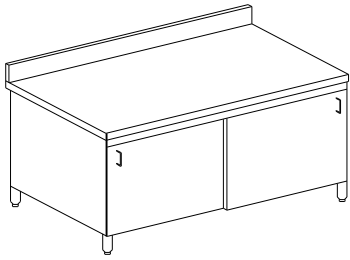
# Banchi armadiati



DESCRIZIONE	Dimensioni			Altre caratteristiche	CODICE
	L	P	H		
Banco armadiato porte scorrevoli  	1200	700	850	4 gambe	TA1207PS0S
	1300	700	850	4 gambe	TA1307PS0S
	1400	700	850	4 gambe	TA1407PS0S
	1500	700	850	4 gambe	TA1507PS0S
	1600	700	850	4 gambe	TA1607PS0S
	1700	700	850	4 gambe	TA1707PS0S
	1800	700	850	4 gambe	TA1807PS0S
	1900	700	850	4 gambe	TA1907PS0S
	2000	700	850	4 gambe	TA2007PS0S
	2100	700	850	4 gambe	TA2107PS0S
	2200	700	850	4 gambe	TA2207PS0S
	2300	700	850	6 gambe	TA2307PS0S
	2400	700	850	6 gambe	TA2407PS0S
	2500	700	850	6 gambe	TA2507PS0S
2600	700	850	6 gambe	TA2607PS0S	
Banco armadiato porte scorrevoli con alzatina  	1200	700	850	4 gambe	TA1207PSAS
	1300	700	850	4 gambe	TA1307PSAS
	1400	700	850	4 gambe	TA1407PSAS
	1500	700	850	4 gambe	TA1507PSAS
	1600	700	850	4 gambe	TA1607PSAS
	1700	700	850	4 gambe	TA1707PSAS
	1800	700	850	4 gambe	TA1807PSAS
	1900	700	850	4 gambe	TA1907PSAS
	2000	700	850	4 gambe	TA2007PSAS
	2100	700	850	4 gambe	TA2107PSAS
	2200	700	850	4 gambe	TA2207PSAS
	2300	700	850	6 gambe	TA2307PSAS
	2400	700	850	6 gambe	TA2407PSAS
	2500	700	850	6 gambe	TA2507PSAS
2600	700	850	6 gambe	TA2607PSAS	

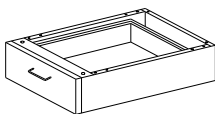
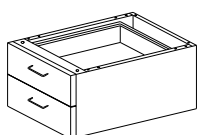

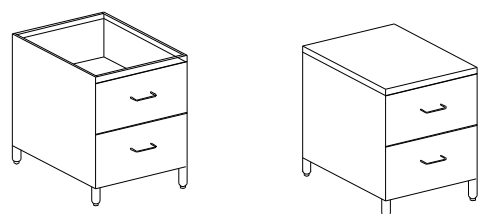
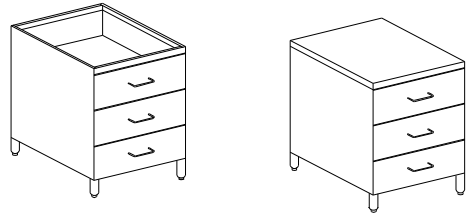
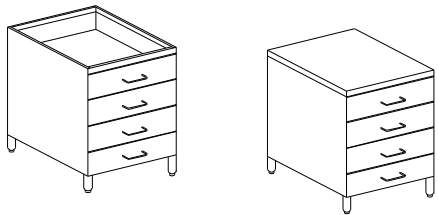
# Cassettiere

DESCRIZIONE	Dimensioni			Altre caratteristiche	CODICE
	L	P	H		
<b>Cassetto sospeso singolo</b> 	400	540	180	guide ad estrazione totale	CA0405TA1S
	400	640	180	guide ad estrazione totale	CA0406TA1S
	500	540	180	guide ad estrazione totale	CA0705TA1S
	500	640	180	guide ad estrazione totale	CA0706TA1S
<b>Cassettiera sospesa a 2 cassetti</b> 	400	540	540	guide ad estrazione totale	CA0405TA2S
	400	640	540	guide ad estrazione totale	CA0406TA2S
<b>Cassettiera sospesa a 3 cassetti</b> 	400	540	540	guide ad estrazione totale	CA0405TA3S
	400	640	540	guide ad estrazione totale	CA0406TA3S
<b>Cassettiera sospesa a 4 cassetti</b> 	400	540	540	guide ad estrazione totale	CA0405TA4S
	400	640	540	guide ad estrazione totale	CA0406TA4S
<b>Cassettiera a 2 cassetti</b> 	400	560	810	senza piano	CA4602C00S
	400	600	850	con piano	CA4562C00S
	400	660	810	senza piano	CA4702C00S
	400	700	850	con piano	CA4662C00S
<b>Cassettiera a 3 cassetti</b> 	400	560	810	senza piano	CA4603C00S
	400	600	850	con piano	CA4563C00S
	400	660	810	senza piano	CA4703C00S
	400	700	850	con piano	CA4663C00S
<b>Cassettiera a 4 cassetti</b> 	400	560	810	senza piano	CA4604C00S
	400	600	850	con piano	CA4564C00S
	400	660	810	senza piano	CA4704C00S
	400	700	850	con piano	CA4664C00S

# Cassettiere

DESCRIZIONE	Dimensioni			Altre caratteristiche	CODICE
	L	P	H		
<b>Cassettiera 2 cassetti e alzatina</b> 	400	600	850	con piano	CA4602C0AS
	400	700	850	con piano	CA4702C0AS
<b>Cassettiera 3 cassetti e alzatina</b> 	400	600	850	con piano	CA4603C0AS
	400	700	850	con piano	CA4703C0AS
<b>Cassettiera 4 cassetti e alzatina</b> 	400	600	850	con piano	CA4604C0AS
	400	700	850	con piano	CA4704C0AS
<b>Sistema antiribaltamento</b>	0	0	0	senza serratura	CA000000AR
	0	0	0	con serratura	CA000000SAR

# Arredi neutri

## LAVATOI ARMADIATI

### Wash cupboards

LAVATOI ARMADIATI interamente in acciaio inox AISI 304 finitura scotch-brite

- Piano del lavello spessore 40 mm con piega salvamani sui bordi
- Alzatina posteriore paraspruzzi H100 mm (se presente)
- Invaso perimetrale
- Vasche in acciaio inox dotate di tubo troppopieno e piletta di scarico
- Gambe regolabili in altezza (60 mm) in modo da garantire un perfetto allineamento con il pavimento e con gli altri elementi presenti nel locale
- Possibilità di completarli a richiesta con rubinetteria
- Adatti per uso sanitario
- Profondità 600 o 700 mm
- Manici in tondino
- Assenza di spigoli vivi e di tagli a contatto raggiungibili anche nelle operazioni di manutenzione e pulizia
- Pannellature con superfici lisce, lavabili
- Sportelli rivestiti con pannellature lato interno e tamburati
- La finitura, le dimensioni e gli accessori che lo compongono sono interamente personalizzabili a seconda delle esigenze di spazio e di utenze del cliente

◦ STRUCTURE made of A304 stainless steel scotch-brite brushed finish

- Worktop thickness 40 mm with upturned edges
- Rear upstand H100 mm (if present)
- Invaded perimeter
- Stainless steel sinks with overflow pipe and drain
- Legs adjustable in height (60 mm) so as to ensure a perfect alignment with the floor and with the other elements present in the local
- Ability to complete them in demand with tap
- Suitable for sanitary use
- Depth 600 or 700 mm
- Handles rod
- No sharp edges and cut points can also be reached in the maintenance and cleaning operations
- Panels with smooth surfaces, washable
- Branches covered with paneling inside and honeycomb
- The finish, size, and accessories that make it up are fully customizable according to the needs of space and loads of customer

# Lavatoio armadiato

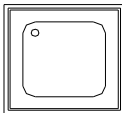
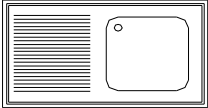
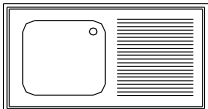
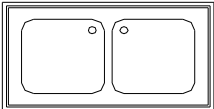
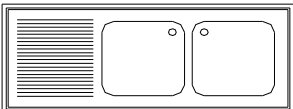
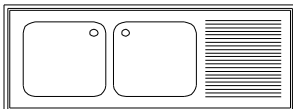
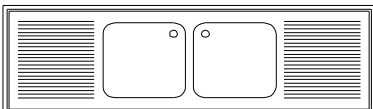
DESCRIZIONE	Dimensioni			Dimensioni vasca	CODICE
	L	P	H		
Lavatoio armadiati (1 vasca) 	600	600	850	500x400x250	LA0661V00S
	700	600	850	500x400x250	LA0761V00S
	800	600	850	500x400x250	LA0861V00S
Lavatoio armadiati (1 vasca + gocc. sx) 	1000	600	850	500x400x250	LA1061VGSS
	1100	600	850	500x400x250	LA1161VGSS
	1200	600	850	500x400x250	LA1261VGSS
	1300	600	850	500x400x250	LA1361VGSS
	1400	600	850	500x400x250	LA1461VGSS
	1500	600	850	500x500x250	LA1561VGSS
	1600	600	850	500x500x250	LA1661VGSS
Lavatoio armadiati (1 vasca + gocc. dx) 	1000	600	850	500x400x250	LA1061VGDS
	1100	600	850	500x400x250	LA1161VGDS
	1200	600	850	500x400x250	LA1261VGDS
	1300	600	850	500x400x250	LA1361VGDS
	1400	600	850	500x400x250	LA1461VGDS
	1500	600	850	500x500x250	LA1561VGDS
	1600	600	850	500x500x250	LA1661VGDS
Lavatoio armadiati (2 vasche) 	1000	600	850	500x400x250	LA1062V00S
	1100	600	850	500x400x250	LA1162V00S
	1200	600	850	500x400x250	LA1262V00S
	1300	600	850	500x400x250	LA1362V00S
	1400	600	850	500x500x250	LA1462V00S
Lavatoio armadiati (2 vasche + gocc. sx) 	1400	600	850	500x400x250	LA1462VGSS
	1500	600	850	500x400x250	LA1562VGSS
	1600	600	850	500x400x250	LA1662VGSS
	1700	600	850	500x400x250	LA1762VGSS
	1800	600	850	500x400x250	LA1862VGSS
	1900	600	850	600x500x300	LA1962VGSS
	2000	600	850	600x500x300	LA2062VGSS
	2000	600	850	600x500x300	LA2062VGSS
Lavatoio armadiati (2 vasche + gocc. dx) 	1400	600	850	500x400x250	LA1462VGDS
	1500	600	850	500x400x250	LA1562VGDS
	1600	600	850	500x400x250	LA1662VGDS
	1700	600	850	500x400x250	LA1762VGDS
	1800	600	850	500x400x250	LA1862VGDS
	1900	600	850	500x400x250	LA1962VGDS
	2000	600	850	500x400x250	LA2062VGDS
	2000	600	850	500x400x250	LA2062VGDS
Lavatoio armadiati (2 vasche + 2 gocc. dx/sx) 	1800	600	850	500x400x250	LA1862V2GS
	2000	600	850	500x400x250	LA2062V2GS
	2200	600	850	500x400x250	LA2262V2GS
	2400	600	850	500x400x250	LA2462V2GS

# Lavatoio armadiato

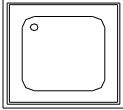
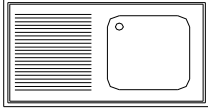
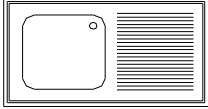
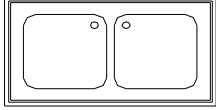
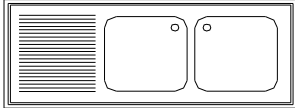
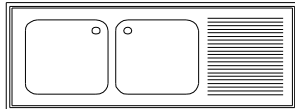
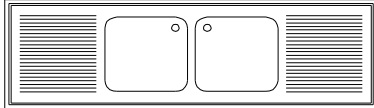
DESCRIZIONE	Dimensioni			Dimensioni vasca	CODICE
	L	P	H		
Lavatoio armadiati (1 vasca) 	600	700	850	400x500x250	LA0671V00S
	700	700	850	500x500x250	LA0771V00S
	800	700	850	600x500x300	LA0871V00S
	1000	700	850	600x500x300	LA1071V00S
Lavatoio armadiati (1 vasca + gocc. sx) 	1000	700	850	400x500x250	LA1071VGSS
	1100	700	850	400x500x250	LA1171VGSS
	1200	700	850	500x500x250	LA1271VGSS
	1300	700	850	600x500x300	LA1371VGSS
	1400	700	850	600x500x300	LA1471VGSS
	1500	700	850	600x500x300	LA1571VGSS
	1600	700	850	600x500x300	LA1671VGSS
Lavatoio armadiati (1 vasca + gocc. dx) 	1000	700	850	400x500x250	LA1071VGDS
	1100	700	850	400x500x250	LA1171VGDS
	1200	700	850	500x500x250	LA1271VGDS
	1300	700	850	600x500x300	LA1371VGDS
	1400	700	850	600x500x300	LA1471VGDS
	1500	700	850	600x500x300	LA1571VGDS
	1600	700	850	600x500x300	LA1671VGDS
Lavatoio armadiati (2 vasche) 	1000	700	850	500x400x250	LA1072V00S
	1100	700	850	500x400x250	LA1172V00S
	1200	700	850	500x500x250	LA1272V00S
	1300	700	850	500x500x250	LA1372V00S
	1400	700	850	600x500x300	LA1472V00S
Lavatoio armadiati (2 vasche + gocc. sx) 	1400	700	850	400x500x250	LA1472VGSS
	1500	700	850	400x500x250	LA1572VGSS
	1600	700	850	400x500x250	LA1672VGSS
	1700	700	850	500x500x250	LA1772VGSS
	1800	700	850	500x500x250	LA1872VGSS
	1900	700	850	600x500x300	LA1972VGSS
	2000	700	850	600x500x300	LA2072VGSS
	2000	700	850	600x500x300	LA2072VGSS
Lavatoio armadiati (2 vasche + gocc. dx) 	1400	700	850	400x500x250	LA1472VGDS
	1500	700	850	400x500x250	LA1572VGDS
	1600	700	850	400x500x250	LA1672VGDS
	1700	700	850	500x500x250	LA1772VGDS
	1800	700	850	500x500x250	LA1872VGDS
	1900	700	850	600x500x300	LA1972VGDS
	2000	700	850	600x500x300	LA2072VGDS
Lavatoio armadiati (2 vasche + 2 gocc. dx/sx) 	1800	700	850	400x500x250	LA1872V2GS
	2000	700	850	500x500x250	LA2072V2GS
	2200	700	850	500x500x250	LA2272V2GS
	2400	700	850	600x500x300	LA2472V2GS

# Lavatoio su gambe

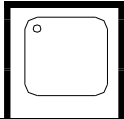
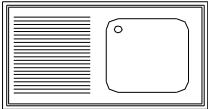
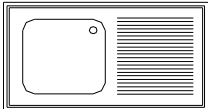
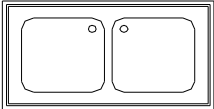
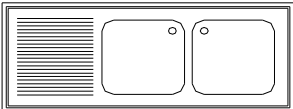
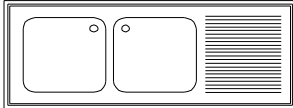
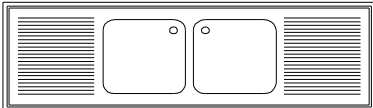
DESCRIZIONE	Dimensioni			Dimensioni vasca	CODICE
	L	P	H		
Lavatoio su gambe (1 vasca) 	600	600	850	500x400x250	LG0661V00S
	700	600	850	500x400x250	LG0761V00S
	800	600	850	500x400x250	LG0861V00S
Lavatoio su gambe (1 vasca + gocc. sx) 	1000	600	850	500x400x250	LG1061VGSS
	1100	600	850	500x400x250	LG1161VGSS
	1200	600	850	500x400x250	LG1261VGSS
	1300	600	850	500x400x250	LG1361VGSS
	1400	600	850	500x400x250	LG1461VGSS
	1500	600	850	500x500x250	LG1561VGSS
	1600	600	850	500x500x250	LG1661VGSS
Lavatoio su gambe (1 vasca + gocc. dx) 	1000	600	850	500x400x250	LG1061VGDS
	1100	600	850	500x400x250	LG1161VGDS
	1200	600	850	500x400x250	LG1261VGDS
	1300	600	850	500x400x250	LG1361VGDS
	1400	600	850	500x400x250	LG1461VGDS
	1500	600	850	500x500x250	LG1561VGDS
	1600	600	850	500x500x250	LG1661VGDS
Lavatoio su gambe (2 vasche) 	1000	600	850	500x400x250	LG1062V00S
	1100	600	850	500x400x250	LG1162V00S
	1200	600	850	500x400x250	LG1262V00S
	1300	600	850	500x400x250	LG1362V00S
	1400	600	850	500x500x250	LG1462V00S
Lavatoio su gambe (2 vasche + gocc. sx) 	1400	600	850	500x400x250	LG1462VGSS
	1500	600	850	500x400x250	LG1562VGSS
	1600	600	850	500x400x250	LG1662VGSS
	1700	600	850	500x400x250	LG1762VGSS
	1800	600	850	500x400x250	LG1862VGSS
	1900	600	850	600x500x300	LG1962VGSS
	2000	600	850	600x500x300	LG2062VGSS
Lavatoio su gambe (2 vasche + gocc. dx) 	1400	600	850	500x400x250	LG1462VGDS
	1500	600	850	500x400x250	LG1562VGDS
	1600	600	850	500x400x250	LG1662VGDS
	1700	600	850	500x400x250	LG1762VGDS
	1800	600	850	500x400x250	LG1862VGDS
	1900	600	850	500x400x250	LG1962VGDS
	2000	600	850	500x400x250	LG2062VGDS
Lavatoio su gambe (2 vasche + 2 gocc. dx/sx) 	1800	600	850	500x400x250	LG1862V2GS
	2000	600	850	500x400x250	LG2062V2GS
	2200	600	850	500x400x250	LG2262V2GS
	2400	600	850	500x400x250	LG2462V2GS

# Lavatoio su gambe

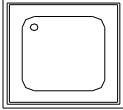
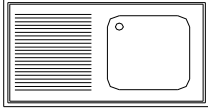
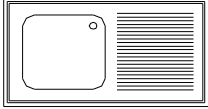
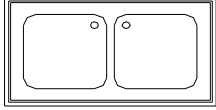
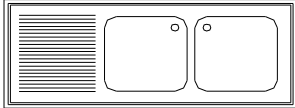
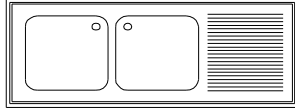
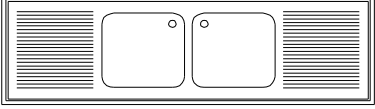

DESCRIZIONE	Dimensioni			Dimensioni vasca	CODICE
	L	P	H		
Lavatoio su gambe (1 vasca) 	600	700	850	400x500x250	LG0671V00S
	700	700	850	500x500x250	LG0771V00S
	800	700	850	600x500x300	LG0871V00S
	1000	700	850	600x500x300	LG1071V00S
Lavatoio su gambe (1 vasca + gocc. sx) 	1000	700	850	400x500x250	LG1071VGSS
	1100	700	850	400x500x250	LG1171VGSS
	1200	700	850	500x500x250	LG1271VGSS
	1300	700	850	600x500x300	LG1371VGSS
	1400	700	850	600x500x300	LG1471VGSS
	1500	700	850	600x500x300	LG1571VGSS
Lavatoio su gambe (1 vasca + gocc. dx) 	1000	700	850	400x500x250	LG1071VGDS
	1100	700	850	400x500x250	LG1171VGDS
	1200	700	850	500x500x250	LG1271VGDS
	1300	700	850	600x500x300	LG1371VGDS
	1400	700	850	600x500x300	LG1471VGDS
	1500	700	850	600x500x300	LG1571VGDS
Lavatoio su gambe (2 vasche) 	1000	700	850	500x400x250	LG1072V00S
	1100	700	850	500x400x250	LG1172V00S
	1200	700	850	500x500x250	LG1272V00S
	1300	700	850	500x500x250	LG1372V00S
	1400	700	850	600x500x300	LG1472V00S
Lavatoio su gambe (2 vasche + gocc. sx) 	1400	700	850	400x500x250	LG1472VGSS
	1500	700	850	400x500x250	LG1572VGSS
	1600	700	850	400x500x250	LG1672VGSS
	1700	700	850	500x500x250	LG1772VGSS
	1800	700	850	500x500x250	LG1872VGSS
	1900	700	850	600x500x300	LG1972VGSS
	2000	700	850	600x500x300	LG2072VGSS
Lavatoio su gambe (2 vasche + gocc. dx) 	1400	700	850	400x500x250	LG1472VGDS
	1500	700	850	400x500x250	LG1572VGDS
	1600	700	850	400x500x250	LG1672VGDS
	1700	700	850	500x500x250	LG1772VGDS
	1800	700	850	500x500x250	LG1872VGDS
	1900	700	850	600x500x300	LG1972VGDS
Lavatoio su gambe (2 vasche + 2 gocc. dx/sx) 	1800	700	850	400x500x250	LG1872V2GS
	2000	700	850	500x500x250	LG2072V2GS
	2200	700	850	500x500x250	LG2272V2GS
	2400	700	850	600x500x300	LG2472V2GS

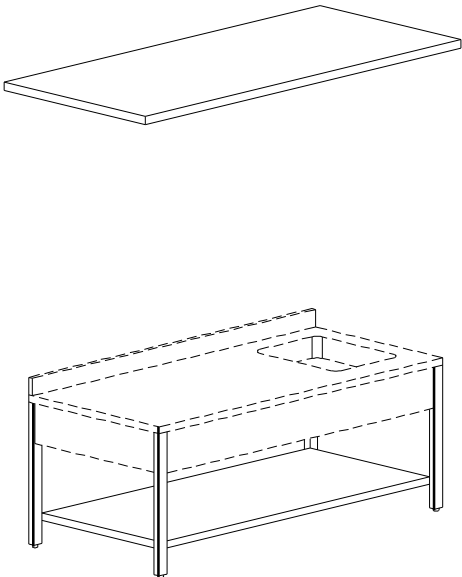
# Lavatoio su gambe

DESCRIZIONE	Dimensioni			Altre caratteristiche	CODICE
	L	P	H		
<p>Ripiani inferiori per lavatoi su gambe</p> 	600	600	40	saldato alla struttura	LG060640RI
	700	600	40	saldato alla struttura	LG070640RI
	800	600	40	saldato alla struttura	LG080640RI
	1000	600	40	saldato alla struttura	LG100640RI
	1100	600	40	saldato alla struttura	LG110640RI
	1200	600	40	saldato alla struttura	LG120640RI
	1300	600	40	saldato alla struttura	LG130640RI
	1400	600	40	saldato alla struttura	LG140640RI
	1500	600	40	saldato alla struttura	LG150640RI
	1600	600	40	saldato alla struttura	LG160640RI
	1700	600	40	saldato alla struttura	LG170640RI
	1800	600	40	saldato alla struttura	LG180640RI
	1900	600	40	saldato alla struttura	LG190640RI
	2000	600	40	saldato alla struttura	LG200640RI
	2200	600	40	saldato alla struttura	LG220640RI
	2400	600	40	saldato alla struttura	LG240640RI
	600	700	40	saldato alla struttura	LG060640RI
	700	700	40	saldato alla struttura	LG070640RI
	800	700	40	saldato alla struttura	LG080740RI
	1000	700	40	saldato alla struttura	LG100740RI
	1100	700	40	saldato alla struttura	LG110740RI
	1200	700	40	saldato alla struttura	LG120740RI
	1300	700	40	saldato alla struttura	LG130740RI
	1400	700	40	saldato alla struttura	LG140740RI
1500	700	40	saldato alla struttura	LG150740RI	
1600	700	40	saldato alla struttura	LG160740RI	
1700	700	40	saldato alla struttura	LG170740RI	
1800	700	40	saldato alla struttura	LG180740RI	
1900	700	40	saldato alla struttura	LG190740RI	
2000	700	40	saldato alla struttura	LG200740RI	
2200	700	40	saldato alla struttura	LG200740RI	
2400	700	40	saldato alla struttura	LG200740RI	

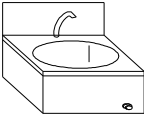
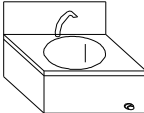
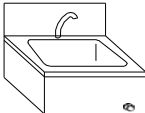

# Lavamani

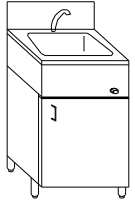
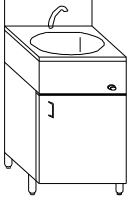
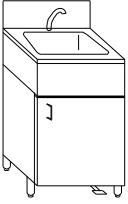
DESCRIZIONE	Dimensioni			Altre caratteristiche	CODICE
	L	P	H		
<p>Lavamani pensile erogatore a ginocchio</p> 	400	350	280	vasca ovale 355x265x125h	LM4035M1GS
<p>Lavamani pensile erogatore a ginocchio</p> 	400	400	280	vasca tonda Ø 320x125h	LM4040M2GS
<p>Lavamani pensile erogatore a ginocchio</p> 	500	350	280	trapezoidale 430x260x125	LM5035M3GS
<p>Lavamani pensile erogatore a ginocchio</p> 	500	500	280	semisferico 415x340x125	LM5050M4GS
<p>Lavamani su armadio - erogatore a ginocchio</p> 	500	350	850	trapezoidale 430x260x125	LM5035A3GS
<p>Lavamani su armadio - erogatore a ginocchio</p> 	500	500	850	semisferico 415x340x125	LM5050A4GS
<p>Lavamani su armadio - erogatore a pedale</p> 	500	500	850	semisferico 415x340x125	LM5050A4PS

# Arredi neutri

## **ARMADI E PENSILI** Cabinets and hangings

ARMADIE PENSILI interamente in acciaio inox AISI 304 finitura scotch-brite

- Ante a battenti o scorrevoli
- Ante scorrevoli senza guide inferiori per una migliore pulizia della base
- Ripiani regolabili in altezza su cremagliere
- Adatti per uso sanitario
- Profondità 400 o 500 mm
- Manici in tondino
- Assenza di spigoli vivi e di tagli a contatto raggiungibili anche nelle operazioni di manutenzione e pulizia
- Pannellature con superfici lisce, lavabili
- Sportelli rivestiti con pannellature lato interno e tamburati
- La finitura, le dimensioni e gli accessori che lo compongono sono interamente personalizzabili a seconda delle esigenze di spazio e di utenze del cliente

- STRUCTURE made of A304 stainless steel scotch-brite brushed finish
- hinged or sliding doors
- Sliding doors without bottom rails for better cleaning of the base
- Adjustable shelves on racks
- Suitable for sanitary use
- Depth 400 or 500 mm
- Handles rod
- No sharp edges and cut points can also be reached in the maintenance and cleaning operations
- Panels with smooth surfaces, washable
- Branches covered with paneling inside and honeycomb

# Pensili

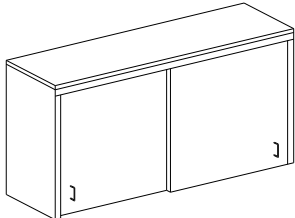
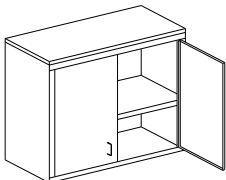
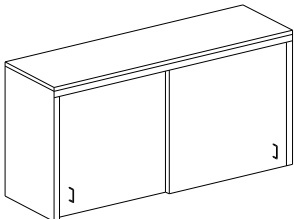
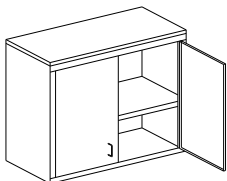
DESCRIZIONE	Dimensioni			Altre caratteristiche	CODICE
	L	P	H		
<p>Pensile con ante scorrevoli</p> 	1100	400	600	1 ripiano	PE11041R0S
	1200	400	600	1 ripiano	PE12041R0S
	1300	400	600	1 ripiano	PE13041R0S
	1400	400	600	1 ripiano	PE14041R0S
	1500	400	600	1 ripiano	PE15041R0S
	1600	400	600	1 ripiano	PE16041R0S
	1700	400	600	1 ripiano	PE17041R0S
	1800	400	600	1 ripiano	PE18041R0S
	1900	400	600	1 ripiano	PE19041R0S
	2000	400	600	1 ripiano	PE20041R0S
	<p>Pensile con ante a battenti</p> 	800	400	600	1 ripiano
900		400	600	1 ripiano	PE09041RBS
1000		400	600	1 ripiano	PE10041RBS
1200		400	600	1 ripiano	PE12041RBS
<p>Pensile con ante scorrevoli</p> 	1100	400	900	2 ripiani	PE11042R0S
	1200	400	900	2 ripiani	PE12042R0S
	1300	400	900	2 ripiani	PE13042R0S
	1400	400	900	2 ripiani	PE14042R0S
	1500	400	900	2 ripiani	PE15042R0S
	1600	400	900	2 ripiani	PE16042R0S
	1700	400	900	2 ripiani	PE17042R0S
	1800	400	900	2 ripiani	PE18042R0S
	1900	400	900	2 ripiani	PE19042R0S
	2000	400	900	2 ripiani	PE20042R0S
<p>Pensile con ante a battenti</p> 	800	400	900	2 ripiani	PE08042RBS
	900	400	900	2 ripiani	PE09042RBS
	1000	400	900	2 ripiani	PE10042RBS
	1200	400	900	2 ripiani	PE12042RBS

# Armadi

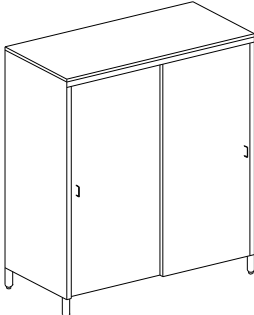
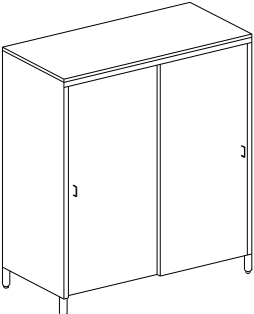
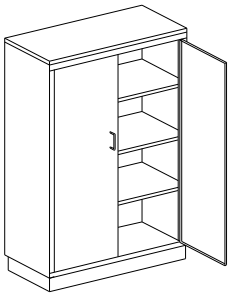
DESCRIZIONE	Dimensioni			Altre caratteristiche	CODICE
	L	P	H		
<p>Armadio ante scorrevoli</p> 	1000	500	2000	4 ripiani	AN1005S3RS
	1100	500	2000	4 ripiani	AN1105S3RS
	1200	500	2000	4 ripiani	AN1205S3RS
	1300	500	2000	4 ripiani	AN1305S3RS
	1400	500	2000	4 ripiani	AN1405S3RS
	1500	500	2000	4 ripiani	AN1505S3RS
	1600	500	2000	4 ripiani	AN1605S3RS
	1700	500	2000	4 ripiani	AN1705S3RS
	1800	500	2000	4 ripiani	AN1805S3RS
	1900	500	2000	4 ripiani	AN1905S3RS
	2000	500	2000	4 ripiani	AN2005S3RS
<p>Armadio ante scorrevoli</p> 	1000	600	2000	4 ripiani	AN1006S3RS
	1100	600	2000	4 ripiani	AN1106S3RS
	1200	600	2000	4 ripiani	AN1206S3RS
	1300	600	2000	4 ripiani	AN1306S3RS
	1400	600	2000	4 ripiani	AN1406S3RS
	1500	600	2000	4 ripiani	AN1506S3RS
	1600	600	2000	4 ripiani	AN1606S3RS
	1700	600	2000	4 ripiani	AN1706S3RS
	1800	600	2000	4 ripiani	AN1806S3RS
	1900	600	2000	4 ripiani	AN1906S3RS
	2000	600	2000	4 ripiani	AN2006S3RS
<p>Armadio ante battenti</p> 	800	500	2000	4 ripiani	AN0805B4RS
	1000	500	2000	4 ripiani	AN1005B4RS
	1200	500	2000	4 ripiani	AN1205B4RS
	800	600	2000	4 ripiani	AN0806B4RS
	1000	600	2000	4 ripiani	AN1006B4RS
	1200	600	2000	4 ripiani	AN1206B4RS

# Ripiani intermedi per pensili e armadi

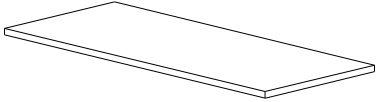
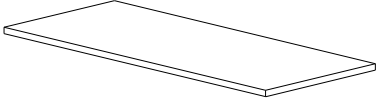
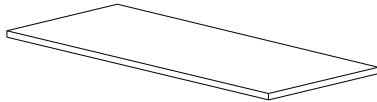
DESCRIZIONE	Dimensioni			Altre caratteristiche	CODICE
	L	P	H		
Ripiani per pensili  	790	300	30		RIP080300S
	890	300	30		RIP090300S
	990	300	30		RIP100300S
	1090	300	30		RIP110300S
	1190	300	30		RIP120300S
	1290	300	30		RIP130300S
	1390	300	30		RIP140300S
	1490	300	30		RIP150300S
	1590	300	30		RIP160300S
	1690	300	30		RIP170300S
	1790	300	30		RIP180300S
	1890	300	30		RIP190300S
Ripiani per armadi neutri  	790	400	30		RIP080400S
	990	400	30		RIP100400S
	1090	400	30		RIP110400S
	1190	400	30		RIP120400S
	1290	400	30		RIP130400S
	1390	400	30		RIP140400S
	1490	400	30		RIP150400S
	1590	400	30		RIP160400S
	1690	400	30		RIP170400S
	1790	400	30		RIP180400S
Ripiani per armadi neutri  	790	500	30		RIP080500S
	990	500	30		RIP100500S
	1090	500	30		RIP110500S
	1190	500	30		RIP120500S
	1290	500	30		RIP130500S
	1390	500	30		RIP140500S
	1490	500	30		RIP150500S
	1590	500	30		RIP160500S
	1690	500	30		RIP170500S
	1790	500	30		RIP180500S
1890	500	30		RIP190500S	
1990	500	30		RIP200500S	



# Arredi neutri

## CARRELLI

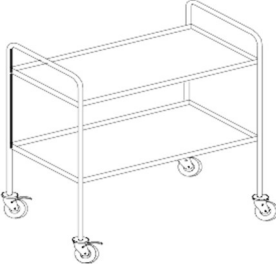
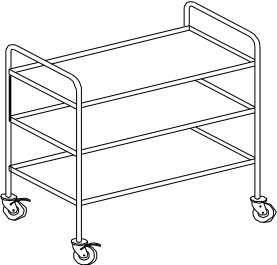
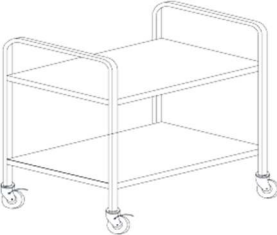

### Trolleys

- STRUTTURA interamente in acciaio inox AISI 304 finitura scotch-brite
  - Ripiani a forma di vassoio con superfici perfettamente arrotondate anche nei bordi inferiori
  - Ruote piroettanti, n. 2 con freno, in gomma grigia
  - Struttura saldata
  - Adatti per uso sanitario
  - Assenza di spigoli vivi e di tagli a contatto raggiungibili anche nelle operazioni di manutenzione e pulizia
  - Pannellature con superfici lisce, lavabili
  - La finitura, le dimensioni e gli accessori che lo compongono sono interamente personalizzabili a seconda delle esigenze di spazio e di utenze del cliente
- STRUTTURA interamente in acciaio inox AISI 304 finitura scotch-brite
- STRUCTURE made of A304 stainless steel scotch-brite brushed finish
  - Shelves in the form of a tray with perfectly rounded surfaces even in the lower edges
  - Revolving wheels, no. 2 with brake, made of gray rubber
  - welded
  - Suitable for sanitary use
  - No sharp edges and cut points can also be reached in the maintenance and cleaning operations
  - Panels with smooth surfaces, washable
  - The finish, size, and accessories that make it up are fully customizable according to the needs of space and loads of customer

# Carrelli a ripiani

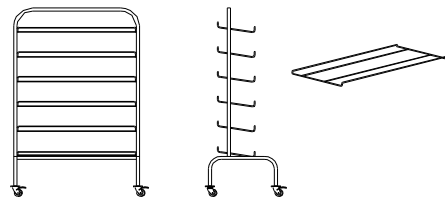
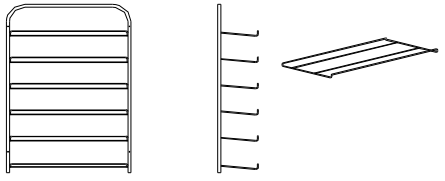

DESCRIZIONE	Dimensioni			Altre caratteristiche	CODICE
	L	P	H		
<p>Carrello a 2 ripiani con vaso</p> 	800	500	900	Struttura componibile	CA08052RIC
	1000	500	900	Struttura componibile	CA10052RIC
<p>Carrello a 3 ripiani con vaso</p> 	800	500	900	Struttura componibile	CA08053RIC
	1000	500	900	Struttura componibile	CA10053RIC
<p>Carrello a due ripiani lisci</p> 	800	500	1000	Struttura saldata	CA08054RIS
	1000	500	1000	Struttura saldata	CA10052RIS
<p>Carrello a due ripiani asportabili</p> 	800	500	1000	Struttura componibile	CA08054RIA
	1000	500	1000	Struttura componibile	CA10052RIA

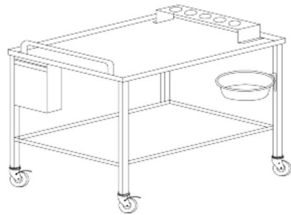
# Carrelli speciali



DESCRIZIONE	Dimensioni			Altre caratteristiche	CODICE
	L	P	H		
<p>Rastrelliera portazoccoli su ruote</p> 	1000	550	1600	n. 6 ripiani in tondino inox diam. 8	RP10326RRU
<p>Rastrelliera portazoccoli da parete</p> 	1000	325	1500	n. 6 ripiani in tondino inox diam. 8	RP10326RPA
<p>Carrello armadiato</p> 	800	500	850		CA0805001S
<p>Carrello medicazione</p> 	900	600	850		CA0906ME1S

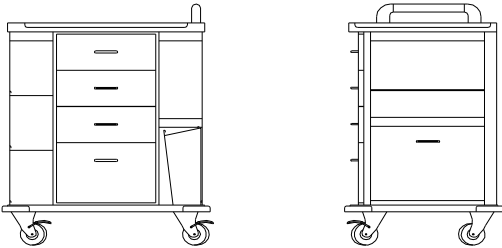
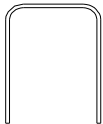
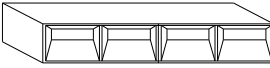

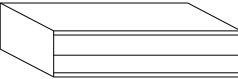
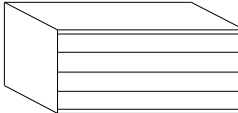
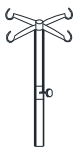
# Carrelli medicali

DESCRIZIONE	Dimensioni			Altre caratteristiche	CODICE
	L	P	H		
<p>Carrello medicale</p> 	844	644	1100		CA0806MEBA
<p>Telaio posteriore carrello medicale</p> 	550	25	850	tubolate 25x25	CAME5585TP
<p>Cassetti ribaltabili</p> 	600	168	207	4 cassetti	CAME004CCR
	600	133	164	5 cassetti	CAME005CCR
	600	91	113	6 cassetti	CAME006CCR
<p>Contenitore porta fili sutura</p> 	600	170	155	capacità 10 confezioni piccole	CAME6010FS
	600	170	290	capacità 20 confezioni piccole	CAME6020FS
<p>Supporto asta portaflebo</p> 	0	0	0		CAME0000SF

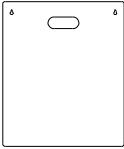
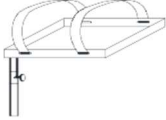
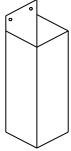



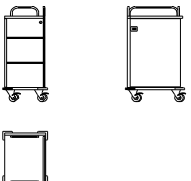
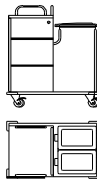
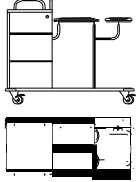
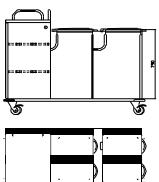
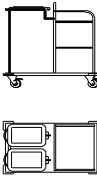
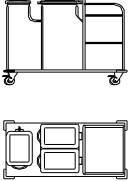
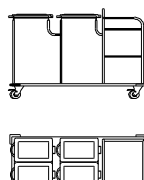
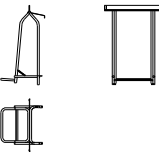

# Carrelli medicali

DESCRIZIONE	Dimensioni			Altre caratteristiche	CODICE
	L	P	H		
Tavoletta massaggio cardiaco 	0	0	0		CAME0000TM
Piano di appoggio defibrillatore 	0	0	0		CAME0000PD
Contenitore portacatetere 	0	0	0		CAME0000CC
Ovali sottomaniglie colorati 	0	0	0	rosso - verde - blu - giallo	CAME0000OC

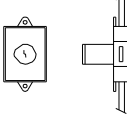
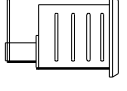
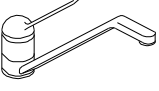
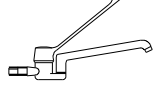
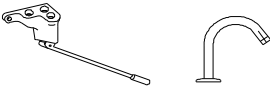
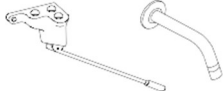

# Carrelli biancheria

DESCRIZIONE	Dimensioni			Altre caratteristiche	CODICE
	L	P	H		
<p>Carrello container per biancheria</p> 	510	674	1200		CACB00001P
<p>Carrello container per biancheria sporco/pulito</p> 	954	674	1200	2 portasacchi	CACB00002P
	1327	674	1200	3 portasacchi	CACB00003P
	1454	674	1200	4 portasacchi	CACB00004P
<p>Carrello a giorno per biancheria sporco/pulito</p> 	1000	670	1050	2 portasacchi	CAGB00002P
	1292	670	1050	3 portasacchi	CAGB00003P
	1431	670	1050	4 portasacchi	CAGB00004P
<p>Pinza fermasacco</p> 	600	390	890		PF000000CB

# Accessori

DESCRIZIONE	Dimensioni			Altre caratteristiche	CODICE
	L	P	H		
Serratura per ante a battenti 	0	0	0		SE0000001S
Serratura per ante scorrevoli 	0	0	0		SE0000002S
Gruppo miscelatore monocomando a leva lunga 	0	0	0	da banco	GRMLM0000S
Gruppo miscelatore monocomando a leva lunga 	0	0	0	a parete	GRMLM0001S
Gruppo miscelatore monocomando a pedale 	0	0	0	da banco	GRMPE0000S
Gruppo miscelatore monocomando a pedale 	0	0	0	a parete	GRMPE0001S
Ruota girevole 	125	30	159		RU125CG00S
Ruota girevole con freno 	125	30	159		RU125CG0FS
Ruota girevole conduttiva 	125	30	159		RU125CGC0S
Ruota girevole conduttiva con freno 	125	30	159		RU125CGCFS
Ruota fissa con supporto su piastra 	125	30	159		RU125PF00S

# Accessori

DESCRIZIONE	Dimensioni			Altre caratteristiche	CODICE
	L	P	H		
Ruota girevole con supporto su piastra 	125	30	159		RU125PG00S
Ruota girevole con freno con supporto su piastra 	125	30	159		RU125PG0FS

# Arredi neutri

## SCAFFALATURE

### Shelving



SCAFFALATURE interamente in acciaio inox AISI 304 finitura scotch-brite

- Montaggio con sistema ad incastro con gancio o a bullone + dado
- Bordi antitaglio
- Ripiani realizzati in spessore 8/10
- Ripiani disponibili sia nella versione alesata che lisci per scaffali a bullone e nella versione ad incastro anche con doghe
- Adatti per celle frigorifere, dispense, arredamenti di grandi cucine e magazzini alimentari
- Adatte per uso sanitario
- La finitura, le dimensioni e gli accessori che lo compongono sono interamente personalizzabili a seconda delle esigenze di spazio e di utenze del cliente

◦ STRUCTURE made of A304 stainless steel scotch-brite brushed finish

- Mounting system with interlocking hook or bolt + nut
- Anti-cut edges
- Shelves made of thickness 8/10
- Shelves available both bored then smooth, while in the interlocking type available also with slats
- Suitable for refrigerators, cupboards, furniture for large kitchens and food storage
- Suitable for sanitary use
- The finish, size, and accessories that make it up are fully customizable according to the needs of space and loads of customer

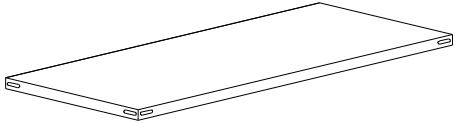
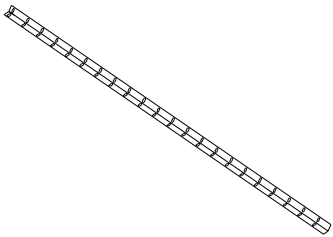
# Scaffalature a bullone

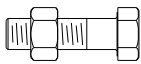
DESCRIZIONE	Dimensioni			Altre caratteristiche	CODICE
	L	P	H		
Ripiani scaffali a bullone lisci 	800	300	30	0 rinforzo	SCB0803RLS
	800	400	30	1 rinforzo	SCB0804RLS
	800	500	30	1 rinforzo	SCB0805RLS
	800	600	30	1 rinforzo	SCB0806RLS
	1000	300	30	0 rinforzo	SCB1003RLS
	1000	400	30	1 rinforzo	SCB1004RLS
	1000	500	30	1 rinforzo	SCB1005RLS
	1000	600	30	1 rinforzo	SCB1006RLS
	1200	300	30	0 rinforzo	SCB1203RLS
	1200	400	30	1 rinforzo	SCB1204RLS
	1200	500	30	1 rinforzo	SCB1205RLS
	1200	600	30	1 rinforzo	SCB1206RLS
Montante a bullone 	35	35	1500		SCB1500MTS
	35	35	1800		SCB1800MTS
	40	40	2000		SCB2000MTS
	35	35	2500		SCB2500MTS
	35	35	3000		SCB3000MTS
Piedino plastica 	35	35	0		SCB3535PPS
Bullone con dado 	0	0	0	M8x15	SCB815BUDS

# Scaffalature ad incastro

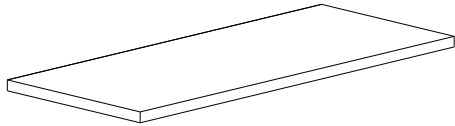
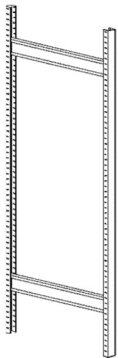
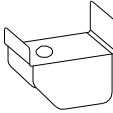
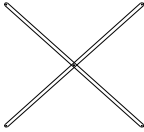
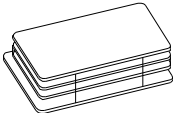
DESCRIZIONE	Dimensioni			Altre caratteristiche	CODICE
	L	P	H		
Ripiani scaffali a gancio lisci 	800	300	30	0 rinforzo	SCG0803RLS
	800	400	30	1 rinforzo	SCG0804RLS
	800	500	30	1 rinforzo	SCG0805RLS
	800	600	30	1 rinforzo	SCG0806RLS
	1000	300	30	0 rinforzo	SCG1003RLS
	1000	400	30	1 rinforzo	SCG1004RLS
	1000	500	30	1 rinforzo	SCG1005RLS
	1000	600	30	1 rinforzo	SCG1006RLS
	1200	300	30	0 rinforzo	SCG1203RLS
	1200	400	30	1 rinforzo	SCG1204RLS
	1200	500	30	1 rinforzo	SCG1205RLS
	1200	600	30	1 rinforzo	SCG1206RLS
	Spalla 	300	40	2000	
400		40	2000		SCG0420SPS
500		40	2000		SCG0520SPS
600		40	2000		SCG0620SPS
Gancio 	0	0	0		SCG00000GS
Crociera 	0	0	2000		SCG2000CRS
Piedino plastica 	0	0	0		SCG0000PPS



# Arredi neutri

## MENSOLE

### Shelves

MENSOLE interamente in acciaio inox AISI 304

- Mensole su staffe fisse con varie lunghezze e profondità
  - Mensole su staffe a cremagliera componibili ad altezze variabili
  - Mensole da tavolo ad uno o due ripiani
  - Adatte per uso sanitario
  - La finitura, le dimensioni e gli accessori che lo compongono sono interamente personalizzabili a seconda delle esigenze di spazio e di utenze del cliente
- 
- STRUCTURE made in A304 stainless steel scotch-brite brushed finish
  - Shelves on brackets fixed with various lengths and depths
  - Shelves on brackets for rack units with variable heights
  - Table shelves with one or two plans
  - Suitable for sanitary use
  - The finish, size, and accessories that make it up are fully customizable according to the needs of space and loads of customer

# Mensole

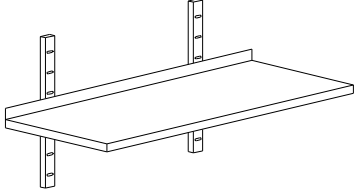
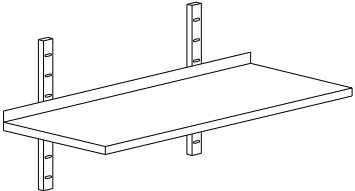
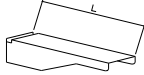
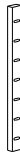
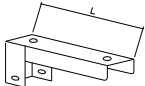
DESCRIZIONE	Dimensioni			Altre caratteristiche	CODICE
	L	P	H		
<b>Mensole</b> 	600	300	40	2 staffe	ML06032STS
	700	300	40	2 staffe	ML07032STS
	800	300	40	2 staffe	ML08032STS
	900	300	40	2 staffe	ML09032STS
	1000	300	40	2 staffe	ML10032STS
	1100	300	40	2 staffe	ML11032STS
	1200	300	40	2 staffe	ML12032STS
	1300	300	40	2 staffe	ML13032STS
	1400	300	40	2 staffe	ML14032STS
	1500	300	40	2 staffe	ML15032STS
	1600	300	40	2 staffe	ML16032STS
	1700	300	40	2 staffe	ML17032STS
	1800	300	40	3 staffe	ML18033STS
	1900	300	40	3 staffe	ML19033STS
2000	300	40	3 staffe	ML20033STS	
<b>Mensole</b> 	600	400	40	2 staffe	ML06042STS
	700	400	40	2 staffe	ML07042STS
	800	400	40	2 staffe	ML08042STS
	900	400	40	2 staffe	ML09042STS
	1000	400	40	2 staffe	ML10042STS
	1100	400	40	2 staffe	ML11042STS
	1200	400	40	2 staffe	ML12042STS
	1300	400	40	2 staffe	ML13042STS
	1400	400	40	2 staffe	ML14042STS
	1500	400	40	2 staffe	ML15042STS
	1600	400	40	2 staffe	ML16042STS
	1700	400	40	2 staffe	ML17042STS
	1800	400	40	3 staffe	ML18043STS
	1900	400	40	3 staffe	ML19043STS
2000	400	40	3 staffe	ML20043STS	
<b>Staffa</b> 	300	0	0		MLST00003S
	400	0	0		MLST00004S
<b>Cremagliera</b> 	0	0	300		MLCR00003S
	0	0	600		MLCR00006S
	0	0	900		MLCR00009S
<b>Staffa fissa</b> 	300	0	0		MLSTF0003S
	400	0	0		MLSTF0004S

# Arredi neutri

## **ARMADIO SPOGLIATOIO E RIPOSTIGLIO**

Lochers and storage cabinets

ARMADI SPOGLIATOIO E RIPOSTIGLIO in acciaio inox AISI 304 finitura scotch brite

- Divisorio interno panni sporchi / panni puliti
- Chiusura a chiave
- Ripiani portascarpe e portacappello
- Ganci appendiabiti per ogni vano
- Tetto inclinato antipolvere
- N. 4 piedini regolabili in altezza
- Ripiani armadi portascopie regolabili in altezza, ripiani fissi per tiracqua
- Struttura saldata
- La finitura, le dimensioni e gli accessori che lo compongono sono interamente personalizzabili a seconda delle esigenze di spazio e di utenze del cliente

- STRUCTURE made in A304 stainless steel scotch-brite brushed finish
- Inner dividing wall dirty / clean clothes
- Under lock and key
- Lower compartment for shoes and hat to top
- Coat hooks
- Sloping roof anti-dust
- N. 4 height adjustable feet
- Structure welded

# Armadi spogliatoio e ripostiglio

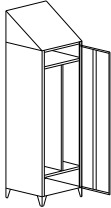
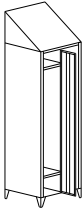
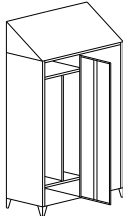
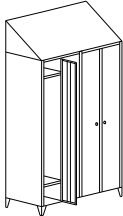
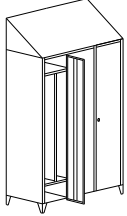
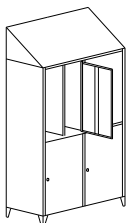
DESCRIZIONE	Dimensioni			Altre caratteristiche	CODICE
	L	P	H		
Armadio spogliatoio 1 posto sporco/pulito 	500	400	2150	1 anta	SP05041SPS
	500	500	2150	1 anta	SP05051SPS
Armadio spogliatoio 1 posto sporco/pulito 	500	400	2150	2 ante	SP05042SPS
	500	500	2150	2 ante	SP05052SPS
Armadio spogliatoio 2 posti sporco/pulito 	950	400	2150	2 ante	SP10042SPS
	950	500	2150	2 ante	SP10052SPS
Armadio spogliatoio 2 posti sporco/pulito 	950	400	2150	4 ante	SP10044SPS
	950	500	2150	4 ante	SP10054SPS
Armadio spogliatoio 3 posti sporco/pulito 	1200	400	2150	3 ante	SP12043SPS
	1200	500	2150	3 ante	SP12053SPS
Armadio spogliatoio a 4 vani sovrapposti sporco/pulito 	950	400	2150	4 ante	SP10044VSS
	950	500	2150	4 ante	SP10054VSS

## Armadi spogliatoio e ripostiglio

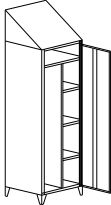
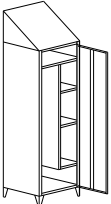
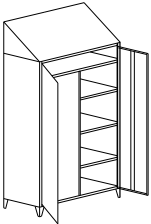
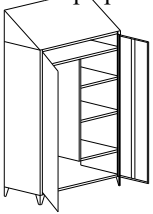
DESCRIZIONE	Dimensioni			Altre caratteristiche	CODICE
	L	P	H		
Armadio portascopie 	500	400	2150	1 anta	PS0504STIS
	500	500	2150	1 anta	PS0505STIS
Armadio portascopie per tiracqua 	500	400	2150	1 anta	PS0504CTIS
	500	500	2150	1 anta	PS0505CTIS
Armadio portascopie 	950	400	2150	2 ante	PS1004STIS
	950	500	2150	2 ante	PS1005STIS
Armadio portascopie per tiracqua 	950	400	2150	2 ante	PS1004CTIS
	950	500	2150	2 ante	PS1005CTIS